



Manual No.'20 • SRF-DB-310

updated July 30, 2020

DATA BOOK

INVERTER FLOOR STANDING TYPE RESIDENTIAL AIR-CONDITIONERS (Split system, air to air heat pump type)

SRF25ZS-W / SRC25ZS-W2

SRF35ZS-W / SRC35ZS-W2

SRF50ZSX-W / SRC50ZSX-W2

CONTENTS

1. SPECIFICATIONS	2
2. EXTERIOR DIMENSIONS	5
(1) Indoor units	5
(2) Outdoor units	6
(3) Remote control	8
3. ELECTRICAL WIRING	11
(1) Indoor units	11
(2) Outdoor units	12
4. NOISE LEVEL	14
5. PIPING SYSTEM	26
6. RANGE OF USAGE & LIMITATIONS	27
7. CAPACITY TABLES	29
8. APPLICATION DATA	30
(1) Installation of indoor unit	30
(2) Installation of outdoor unit	34
(3) Safety precautions in handling air-conditioners with flammable refrigerants	42
9. OPTION PARTS	44
(1) Wired remote control	44
(2) Interface kit (SC-BIKN2-E)	60
(3) Superlink E board (SC-ADNA-E)	64
10. TECHNICAL INFORMATION	66

■ How to read the model name

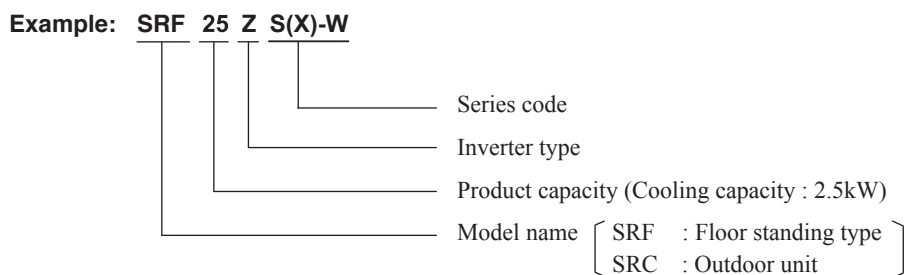

1. SPECIFICATIONS

Item		Model	Indoor unit		Outdoor unit		
			SRF25ZS-W		SRC25ZS-W2		
Power source			1 Phase, 220 - 240V, 50Hz / 220V, 60Hz				
Operation data	Nominal cooling capacity (range)		kW		2.5 (0.9 (Min.) - 3.1 (Max.))		
	Nominal heating capacity (range)		kW		2.9 (0.8 (Min.) - 3.7 (Max.))		
	Heating capacity (H2)		kW		-		
	Power consumption	Cooling	kW		0.59 (0.19 - 0.89)		
			Heating	kW		0.66 (0.20 - 1.14)	
		Heating (H2)		kW		-	
	Max power consumption		kW		1.65		
	Running current	Cooling	A	220/ 230/ 240 V		3.1 / 3.0 / 2.9	
		Heating		220/ 230/ 240 V		3.4 / 3.3 / 3.1	
	Inrush current, max current		A		3.3 Max. 9		
	Power factor	Cooling	%			86	
		Heating				88	
	EER	Cooling			4.24		
	COP	Heating			4.39		
		Heating (H2)			-		
Sound power level	Cooling	dB(A)			50		
	Heating				51		
Sound pressure level	Cooling	dB(A)	Hi: 38 Me: 32 Lo: 29 ULo: 25		45		
	Heating		Hi: 39 Me: 35 Lo: 33 ULo: 29		47		
Silent mode sound pressure level				-			
Exterior dimensions (Height x Width x Depth)		mm		600 x 860 x 238			
Exterior appearance (Equivalent color)				Fine snow Munsell: (8.0Y 9.3/0.1), RAL: 9003			
Net weight		kg		18			
Compressor type & Quantity				-			
Compressor motor (Starting method)		kW		-			
Refrigerant oil (Amount, type)		L		-			
Refrigerant (Type, amount, pre-charge length)		kg		R32 0.62 in outdoor unit (Incl. the amount for the piping of 10m)			
Heat exchanger				Louver fins & inner grooved tubing			
Refrigerant control				Capillary tubes + Electronic expansion valve			
Fan type & Quantity				Turbo fan x 1			
Fan motor (Starting method)		W		40 x 1 (Direct drive)			
Air flow	Cooling	m³/min	Hi: 9.0 Me: 7.6 Lo: 6.7 ULo: 5.8		27.4		
	Heating		Hi: 10.5 Me: 8.2 Lo: 7.7 ULo: 6.6		27.4		
Available external static pressure		Pa		0			
Outside air intake				Not possible			
Air filter, Quality / Quantity				Polypropylene net (Washable) x 2			
Shock & vibration absorber				Rubber sleeve (for fan motor)			
Electric heater				-			
Operation control	Remote control				Wireless remote control		
	Room temperature control				Microcomputer thermostat		
	Operation display				RUN: Green, TIMER: Yellow, ECO: Blue		
Safety equipments				Compressor overheat protection, Overcurrent protection, Frost protection, Serial signal error protection, Indoor fan motor error protection, Heating overload protection(High pressure control), Cooling overload protection			
Installation data	Refrigerant piping size (O.D.)		mm		Liquid line: ϕ 6.35 (1/4") Gas line: ϕ 9.52 (3/8")		
	Connecting method				Flare connection		
	Attached length of piping		m		-		
	Insulation for piping				Necessary (Both sides), independent		
	Refrigerant line (one way) length		m		Max.20		
	Vertical height diff. between O/U and I/U		m		Max.10 (Outdoor unit is higher) / Max.10 (Outdoor unit is lower)		
Drain hose				Hose connectable (VP16)			
Drain pump, max lift height		mm		-			
Recommended breaker size		A		16			
L.R.A. (Locked rotor ampere)		A		3.6			
Interconnecting wires		Size x Core number		1.5mm ² x 4 cores (Including earth cable) / Terminal block (Screw fixing type)			
IP number				IPX0			
Standard accessories				Mounting kit, Clean filter (Allergen clear filter x 1, Photocatalytic washable deodorizing filter x 1)			
Option parts				Interface kit (SC-BIKN2-E)			

Notes (1) The data are measured at the following conditions.

The pipe length is 5m.

Operation	Item	Indoor air temperature		Outdoor air temperature		Standards
		DB	WB	DB	WB	
Cooling		27°C	19°C	35°C	24°C	ISO5151-T1
Heating		20°C	-	7°C	6°C	ISO5151-H1
Heating (H2)		20°C	-	2°C	1°C	ISO5151-H2

(2) This air-conditioner is manufactured and tested in conformity with the ISO.

(3) Sound level indicates the value in an anechoic chamber. During operation these values are somewhat higher due to ambient conditions.

(4) Select the breaker size according to the own national standard.

RWA000Z283

Item		Model	Indoor unit		Outdoor unit		
			SRF35ZS-W		SRC35ZS-W2		
Power source			1 Phase, 220 - 240V, 50Hz / 220V, 60Hz				
Operation data	Nominal cooling capacity (range)		kW		3.5 (0.9 (Min.) - 4.1 (Max.))		
	Nominal heating capacity (range)		kW		4.5 (0.8 (Min.) - 5.2 (Max.))		
	Heating capacity (H2)		kW		—		
	Power consumption	Cooling	kW		0.82 (0.18 - 1.33)		
			kW		1.12 (0.19 - 1.53)		
		Heating (H2)	kW		—		
	Max power consumption		kW		1.65		
	Running current	Cooling	A	A		4.1 / 3.9 / 3.7 (220/ 230/ 240 V)	
		Heating		A		5.4 / 5.1 / 4.9 (220/ 230/ 240 V)	
	Inrush current, max current		A		5.0 Max. 9		
	Power factor	Cooling	%	%		92	
		Heating		%		95	
	EER	Cooling	EER		4.27		
	COP	Heating	COP		4.02		
		Heating (H2)	COP		—		
Sound power level	Cooling	dB(A)	dB(A)		51		
	Heating		dB(A)		52		
Sound pressure level	Cooling	dB(A)	dB(A)		Hi: 40 Me: 35 Lo: 33 ULo: 29		
	Heating		dB(A)		Hi: 41 Me: 36 Lo: 35 ULo: 33		
Silent mode sound pressure level		dB(A)		—			
Exterior dimensions (Height x Width x Depth)		mm		600 × 860 × 238			
Exterior appearance (Equivalent color)				Fine snow Munsell: (8.0Y 9.3/0.1), RAL: 9003			
Net weight		kg		19			
Compressor type & Quantity				—			
Compressor motor (Starting method)		kW		—			
Refrigerant oil (Amount, type)		L		—			
Refrigerant (Type, amount, pre-charge length)		kg		R32 0.78 in outdoor unit (Incl. the amount for the piping of 15m)			
Heat exchanger				Louver fins & inner grooved tubing			
Refrigerant control				Capillary tubes + Electronic expansion valve			
Fan type & Quantity				Turbo fan × 1			
Fan motor (Starting method)		W		40 × 1 (Direct drive)			
Air flow	Cooling	m³/min	m³/min		Hi: 9.2 Me: 7.8 Lo: 7.3 ULo: 6.4		
	Heating		m³/min		Hi: 10.7 Me: 8.3 Lo: 8.1 ULo: 7.4		
Available external static pressure		Pa		0			
Outside air intake				Not possible			
Air filter, Quality / Quantity				Polypropylene net (Washable) × 2			
Shock & vibration absorber				Rubber sleeve (for fan motor)			
Electric heater				—			
Operation control	Remote control				Wireless remote control		
	Room temperature control				Microcomputer thermostat		
	Operation display				RUN: Green, TIMER: Yellow, ECO: Blue		
Safety equipments				Compressor overheat protection, Overcurrent protection, Frost protection, Serial signal error protection, Indoor fan motor error protection, Heating overload protection(High pressure control), Cooling overload protection			
Installation data	Refrigerant piping size (O.D.)		mm		Liquid line: ϕ 6.35 (1/4") Gas line: ϕ 9.52 (3/8")		
	Connecting method				Flare connection		
	Attached length of piping		m		—		
	Insulation for piping				Necessary (Both sides), independent		
	Refrigerant line (one way) length		m		Max.20		
	Vertical height diff. between O/U and I/U		m		Max.10 (Outdoor unit is higher) / Max.10 (Outdoor unit is lower)		
Drain hose				Hose connectable (VP16)			
Drain pump, max lift height		mm		—			
Recommended breaker size		A		16			
L.R.A. (Locked rotor ampere)		A		4.4			
Interconnecting wires		Size x Core number		1.5mm ² × 4 cores (Including earth cable) / Terminal block (Screw fixing type)			
IP number				IPX0			
Standard accessories				Mounting kit, Clean filter (Allergen clear filter × 1, Photocatalytic washable deodorizing filter × 1)			
Option parts				Interface kit (SC-BIKN2-E)			
Notes (1) The data are measured at the following conditions.			The pipe length is 5m.				
Operation	Item	Indoor air temperature		Outdoor air temperature		Standards	
		DB	WB	DB	WB		
	Cooling	27°C	19°C	35°C	24°C	ISO5151-T1	
	Heating	20°C	—	7°C	6°C	ISO5151-H1	
Heating (H2)	20°C	—	2°C	1°C	ISO5151-H2		

(2) This air-conditioner is manufactured and tested in conformity with the ISO.

(3) Sound level indicates the value in an anechoic chamber. During operation these values are somewhat higher due to ambient conditions.

(4) Select the breaker size according to the own national standard.

RWA000Z283

Item		Model	Indoor unit		Outdoor unit	
			SRF50ZSX-W		SRC50ZSX-W2	
Power source			1 Phase, 220 - 240V, 50Hz / 220V, 60Hz			
Operation data	Nominal cooling capacity (range)		kW		5.0 (1.1 (Min.) - 5.6 (Max.))	
	Nominal heating capacity (range)		kW		6.0 (0.8 (Min.) - 7.4 (Max.))	
	Heating capacity (H2)		kW		-	
	Power consumption	Cooling	kW		1.32 (0.19 - 1.90)	
			kW		1.58 (0.19 - 2.34)	
		Heating (H2)	kW		-	
	Max power consumption		kW		2.90	
	Running current	Cooling	A	6.1 / 5.8 / 5.6 (220/ 230/ 240 V)		
		Heating		7.3 / 6.9 / 6.6 (220/ 230/ 240 V)		
	Inrush current, max current		A		5.0 Max. 9	
	Power factor	Cooling	%	99		
		Heating		99		
	EER	Cooling	3.79			
	COP	Heating	3.80			
		Heating (H2)	-			
Sound power level	Cooling	dB(A)	58		63	
	Heating		58		62	
Sound pressure level	Cooling	dB(A)	Hi: 46 Me: 38 Lo: 33 ULo: 28		51	
	Heating		Hi: 46 Me: 41 Lo: 38 ULo: 32		51	
Silent mode sound pressure level		dB(A)		-		
Exterior dimensions (Height x Width x Depth)		mm	600 × 860 × 238		640 × 800(+71) × 290	
Exterior appearance (Equivalent color)			Fine snow Munsell: (8.0Y 9.3/0.1), RAL: 9003		Stucco white Munsell: (4.2Y 7.5/1.1), RAL: 7044	
Net weight		kg	19		45	
Compressor type & Quantity			-		RMT5113SWE11(Twin Rotary type) × 1	
Compressor motor (Starting method)		kW	-		1.50 (Inverter driven)	
Refrigerant oil (Amount, type)		L	-		0.45 (DIAMOND FREEZE MB75)	
Refrigerant (Type, amount, pre-charge length)		kg	R32 1.30 in outdoor unit (Incl. the amount for the piping of 15m)			
Heat exchanger			Louver fins & inner grooved tubing		M fins & inner grooved tubing	
Refrigerant control			Capillary tubes + Electronic expansion valve			
Fan type & Quantity			Turbo fan × 1		Propeller fan × 1	
Fan motor (Starting method)		W	40 × 1 (Direct drive)		34 × 1 (Direct drive)	
Air flow	Cooling	m³/min	Hi: 11.5 Me: 9.6 Lo: 7.4 ULo: 6.6		39.0	
	Heating		Hi: 12.0 Me: 10.0 Lo: 9.4 ULo: 7.6		33.0	
Available external static pressure		Pa	0		0	
Outside air intake			Not possible		-	
Air filter, Quality / Quantity			Polypropylene net (Washable) × 2		-	
Shock & vibration absorber			Rubber sleeve (for fan motor)		Rubber sleeve (for fan motor & compressor)	
Electric heater			-		-	
Operation control	Remote control		Wireless remote control			
	Room temperature control		Microcomputer thermostat			
	Operation display		RUN: Green, TIMER: Yellow, ECO: Blue			
Safety equipments			Compressor overheat protection, Overcurrent protection, Frost protection, Serial signal error protection, Indoor fan motor error protection, Heating overload protection(High pressure control), Cooling overload protection			
Installation data	Refrigerant piping size (O.D.)		mm	Liquid line: φ6.35 (1/4") Gas line: φ 12.7 (1/2")		
	Connecting method			Flare connection Flare connection		
	Attached length of piping		m	-		
	Insulation for piping			Necessary (Both sides), independent		
	Refrigerant line (one way) length		m	Max.30		
	Vertical height diff. between O/U and I/U		m	Max.20 (Outdoor unit is higher) / Max.20 (Outdoor unit is lower)		
Drain hose			Hose connectable (VP16)		Hole φ20 × 5 pcs.	
Drain pump, max lift height		mm	-		-	
Recommended breaker size		A	20			
L.R.A. (Locked rotor ampere)		A	5.0			
Interconnecting wires		Size x Core number	1.5mm ² × 4 cores (Including earth cable) / Terminal block (Screw fixing type)			
IP number			IPX0		IPX4	
Standard accessories			Mounting kit, Clean filter (Allergen clear filter × 1, Photocatalytic washable deodorizing filter × 1)			
Option parts			Interface kit (SC-BIKN2-E)			

Notes (1) The data are measured at the following conditions.

The pipe length is 5m.

Operation	Item	Indoor air temperature		Outdoor air temperature		Standards
		DB	WB	DB	WB	
Cooling		27°C	19°C	35°C	24°C	ISO5151-T1
Heating		20°C	-	7°C	6°C	ISO5151-H1
Heating (H2)		20°C	-	2°C	1°C	ISO5151-H2

(2) This air-conditioner is manufactured and tested in conformity with the ISO.

(3) Sound level indicates the value in an anechoic chamber. During operation these values are somewhat higher due to ambient conditions.

(4) Select the breaker size according to the own national standard.

RWA000Z283

2. EXTERIOR DIMENSIONS

(1) Indoor units

Models SRF25ZS-W, 35ZS-W, 50ZSX-W

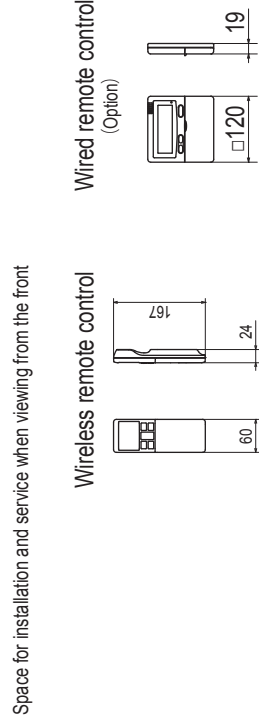
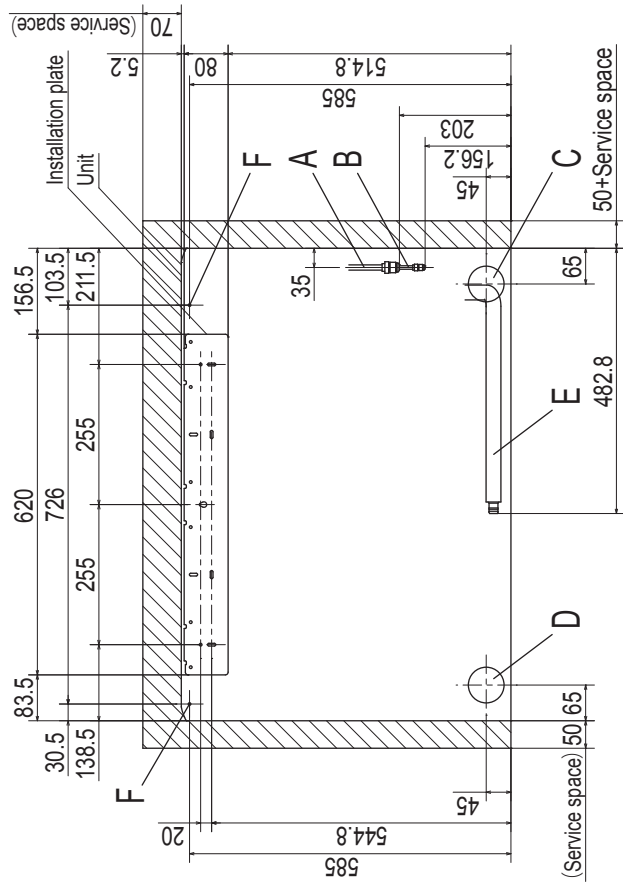

Notes
 (1) The model name label is attached on the rightside of the unit.
 (2) It takes the interface kit (SC-BKN2-E) to connect the wired remote control.
 (3) In case of wall installation, leave the unit 150mm or less from the floor.

Unit:mm

Symbol	Content
A	Gas piping Model 25.35 : φ9.52(3/8") (Flare) 50 : φ12.7(1/2") (Flare)
B	Liquid piping φ6.35(1/4") (Flare)
C	Hole on wall for right rear piping (φ65)
D	Hole on wall for left rear piping (φ65)
E	Drain hose VP16
F	Screw point fasten the indoor unit φ5
G	Outlet for piping (on both side)

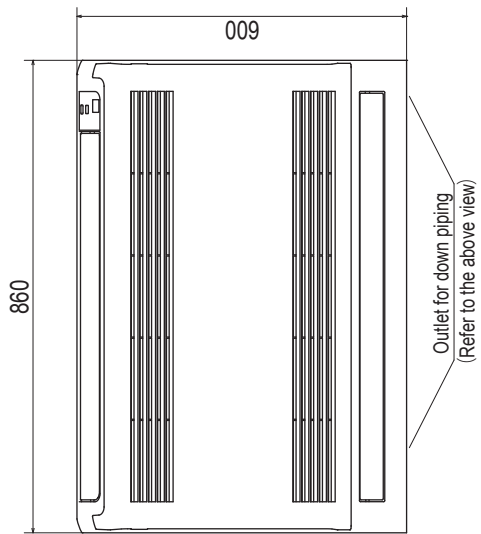
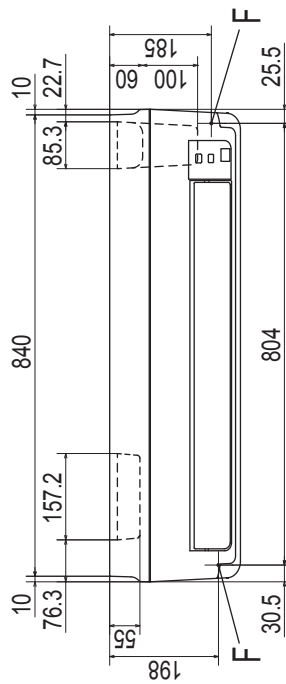

RFB000Z006

(2) Outdoor units
Models SRC25ZS-W2, 35ZS-W2

- Notes (1) The unit must not be surrounded by walls on the four sides.
 (2) The unit must be fixed with anchor bolts. An anchor bolt must not protrude more than 15mm.
 (3) If the unit is installed in the location where there is a possibility of strong winds, place the unit such that the direction of air from the outlet gets perpendicular to the wind direction.
 (4) Leave 200mm or more space above the unit.
 (5) The wall height on the outlet side should be 1200mm or less.
 (6) The model name label is attached on the right side of the unit.

Symbol	Content
A	Service valve connection (gas side) $\phi 9.52$ (3/8") (Flare)
B	Service valve connection (liquid side) $\phi 6.35$ (1/4") (Flare)
C	Pipe/cable draw-out hole
D	Drain discharge hole $\phi 20 \times 2$ places
E	Anchor bolt hole M10-12 \times 4 places

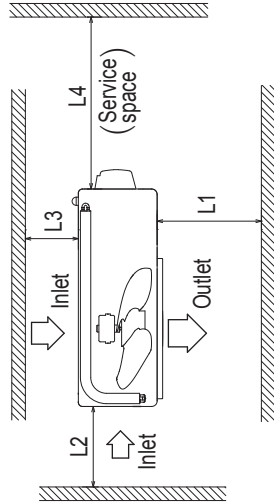
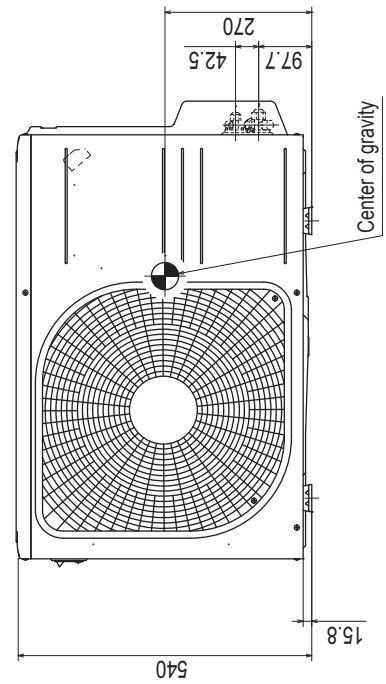
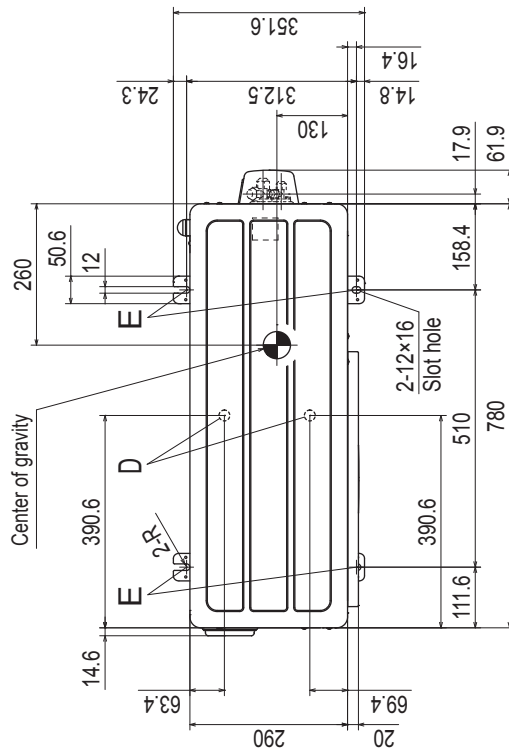

Installation space	
L1	280 or more
L2	100 or more
L3	80 or more
L4	250 or more

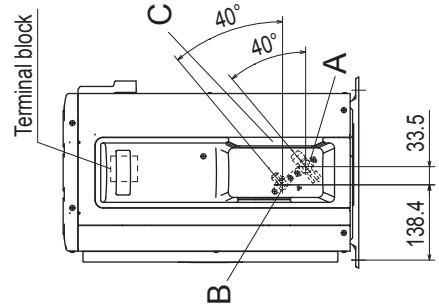

Unit:mm

Model SRC50ZSX-W2

Symbol	Content
A	Service valve connection (gas side) $\phi 12.7(1/2")$ (Flare)
B	Service valve connection (liquid side) $\phi 6.35(1/4")$ (Flare)
C	Pipe/cable draw-out hole
D	Drain discharge hole $\phi 20 \times 5$ places
E	Anchor bolt hole M10-12 \times 4 places

Notes

- (1) The unit must not be surrounded by walls on the four sides.
- (2) The unit must be fixed with anchor bolts. An anchor bolt must not protrude more than 15mm.
- (3) If the unit is installed in the location where there is a possibility of strong winds, place the unit such that the direction of air from the outlet gets perpendicular to the wind direction.
- (4) Leave 200mm or more space above the unit.
- (5) The wall height on the outlet side should be 1200mm or less.
- (6) The model name label is attached on the front side of the unit.

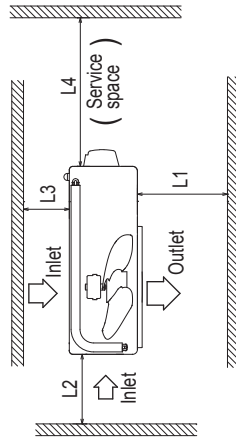
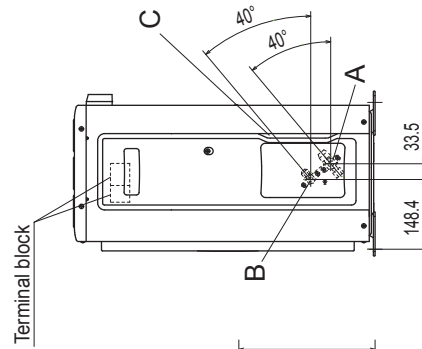
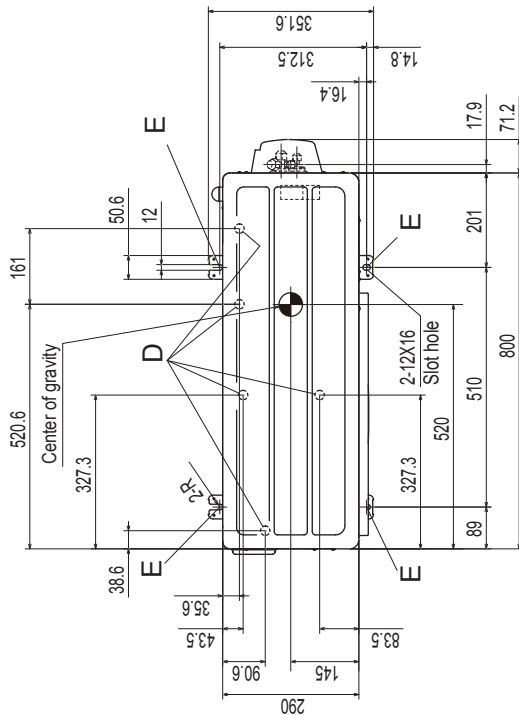

Minimum installation space

Examples installation Size	I	II	III	IV
L1	Open	280	280	180
L2	100	75	Open	Open
L3	100	80	80	80
L4	250	Open	250	Open

Unit:mm

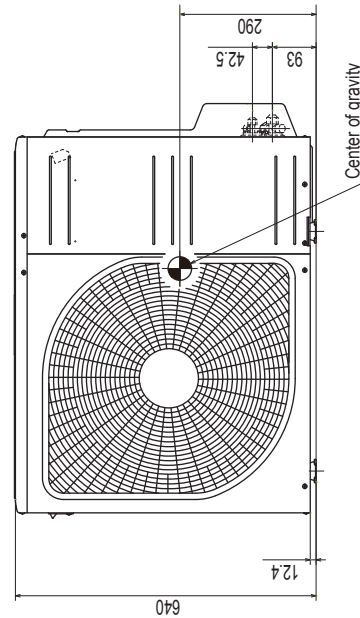

(3) Remote control

(a) Wireless remote control

Unit : mm

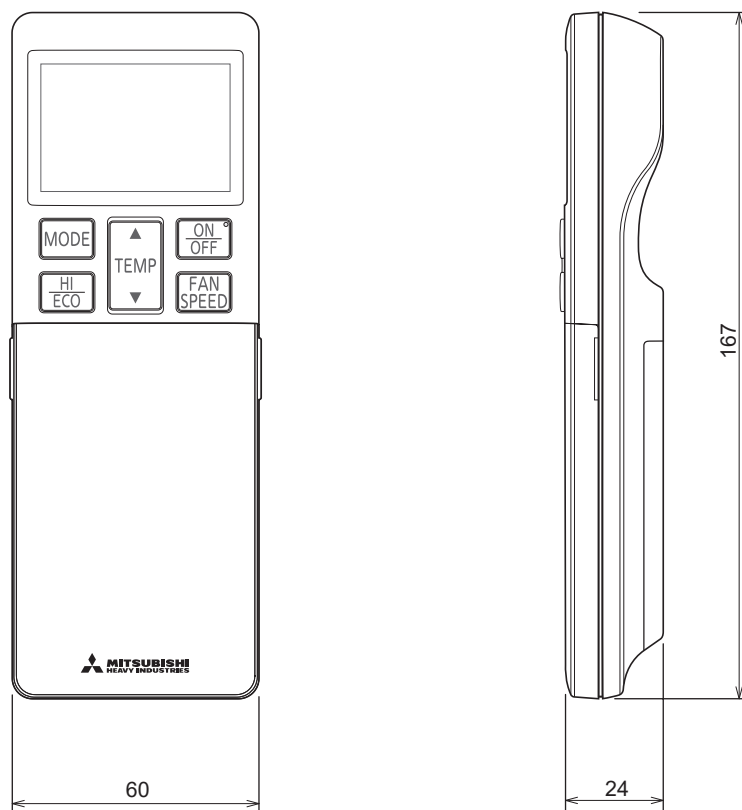

(b) Wired remote control (Option parts)

Interface kit (SC-BIKN2-E) is required to use the wired remote control.

Model RC-EX3A

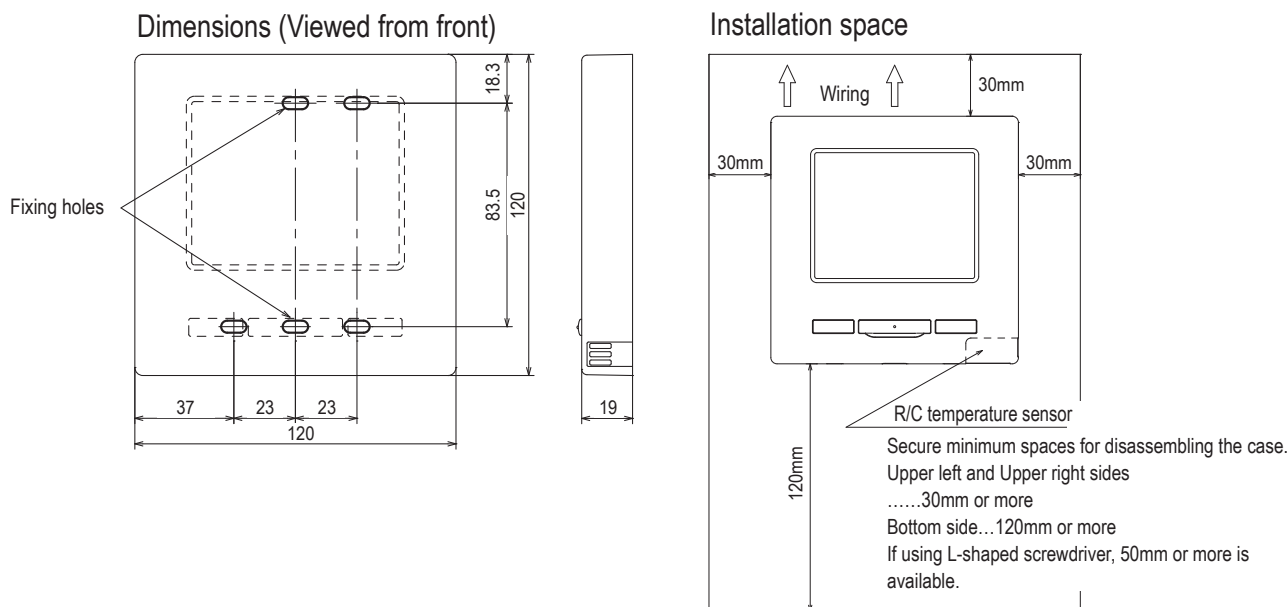

Do not install the remote control at following places.

- ① It could cause break-down or deformation of remote control.
 - Where it is exposed to direct sunlight
 - Where the ambient temperature becomes 0 °C or below, or 40 °C or above
 - Where the surface is not flat
 - Where the strength of installation area is insufficient
- ② Moisture may be attached to internal parts of the remote control, resulting in a display failure.
 - Place with high humidity where condensation occurs on the remote control
 - Where the remote control gets wet
- ③ Accurate room temperature may not be detected using the temperature sensor of the remote control.
 - Where the average room temperature cannot be detected
 - Place near the equipment to generate heat
 - Place affected by outside air in opening/closing the door
 - Place exposed to direct sunlight or wind from air-conditioner
 - Where the difference between wall and room temperature is large
- ④ When you are using the automatic grille up and down panel in the IU, you may not be able to confirm the up and down motion.
 - Where the IU cannot be visually confirmed

R/C cable: 0.3mm² x 2 cores

When the cable length is longer than 100 m, the max size for wires used in the R/C case is 0.5 mm². Connect them to wires of larger size near the outside of R/C. When wires are connected, take measures to prevent water, etc. from entering inside.

≦ 200 m	0.5 mm ² x 2 cores
≦ 300m	0.75 mm ² x 2 cores
≦ 400m	1.25 mm ² x 2 cores
≦ 600m	2.0 mm ² x 2 cores

When installing the unit at a hospital, telecommunication facility, etc., take measures to suppress electric noises.

It could cause malfunction or break-down due to hazardous effects on the inverter, private power generator, high frequency medical equipment, radio communication equipment, etc.

The influences transmitted from the remote control to medical or communication equipment could disrupt medical activities, video broadcasting or cause noise interference.

Adapted RoHS directive

PJZ000Z333

Model RC-E5

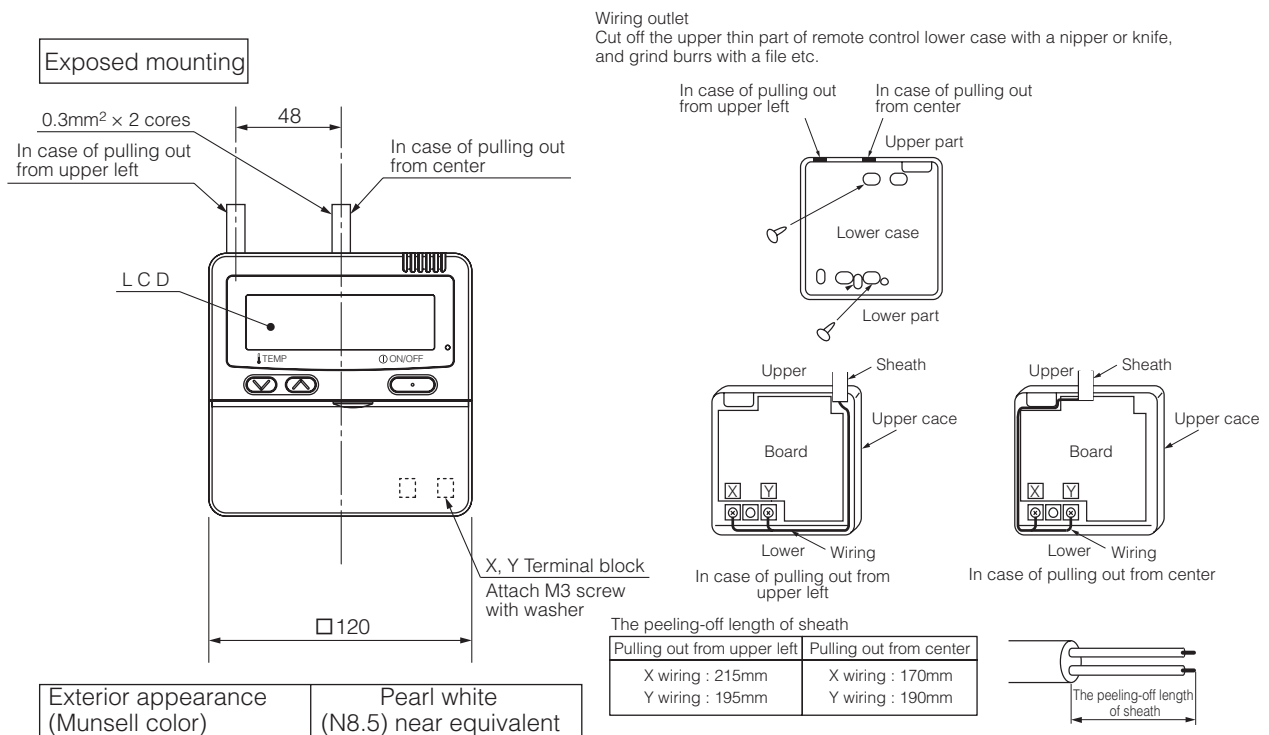

Embedded mounting

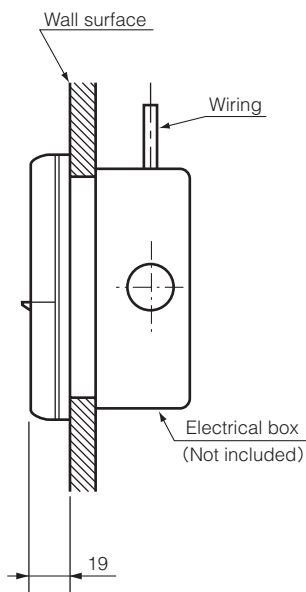

Remote control installation dimensions

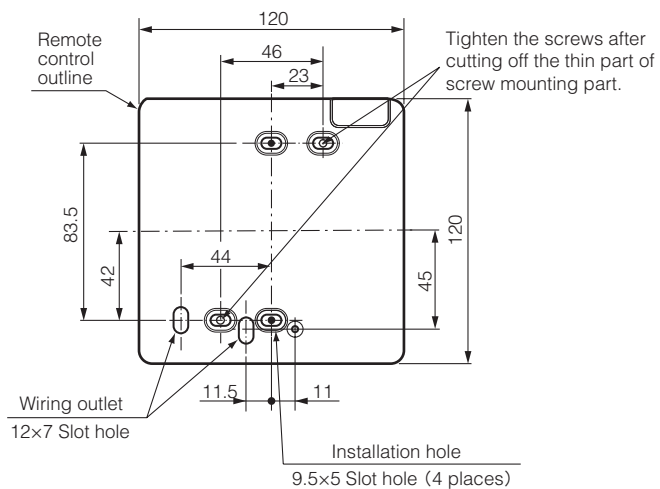

- 1) Installation screw for remote control
M4 screw (2 pieces)

Unit:mm

Wiring specifications

- 1) If the prolongation is over 100m, change to the size below.
But, wiring in the remote control case should be under 0.5mm². Change the wire size outside of the case according to wire connecting. Waterproof treatment is necessary at the wire connecting section. Be careful about contact failure.

Length	Wiring thickness
100 to 200m	0.5mm ² × 2 cores
Under 300m	0.75mm ² × 2 cores
Under 400m	1.25mm ² × 2 cores
Under 600m	2.0mm ² × 2 cores

PJZ000Z295

3. ELECTRICAL WIRING

(1) Indoor units

Models SRF25ZS-W, 35ZS-W, 50ZSX-W

Meaning of marks

Item	Description
CNE-CN2	Connector
FMi	Fan motor
SM1,2	Flap motor
DM1	Damper motor
DM2	Damper arm motor
Th1	Room temperature sensor
Th2,1,2	Heat exchanger temperature sensor
Th3	Humidity sensor
DS	Diode stack
F	Fuse
T	Terminal block
Va	Varistor

Color marks	Color
BK	Black
BL	Blue
RD	Red
WH	White
Y	Yellow
Y/G	Yellow / Green

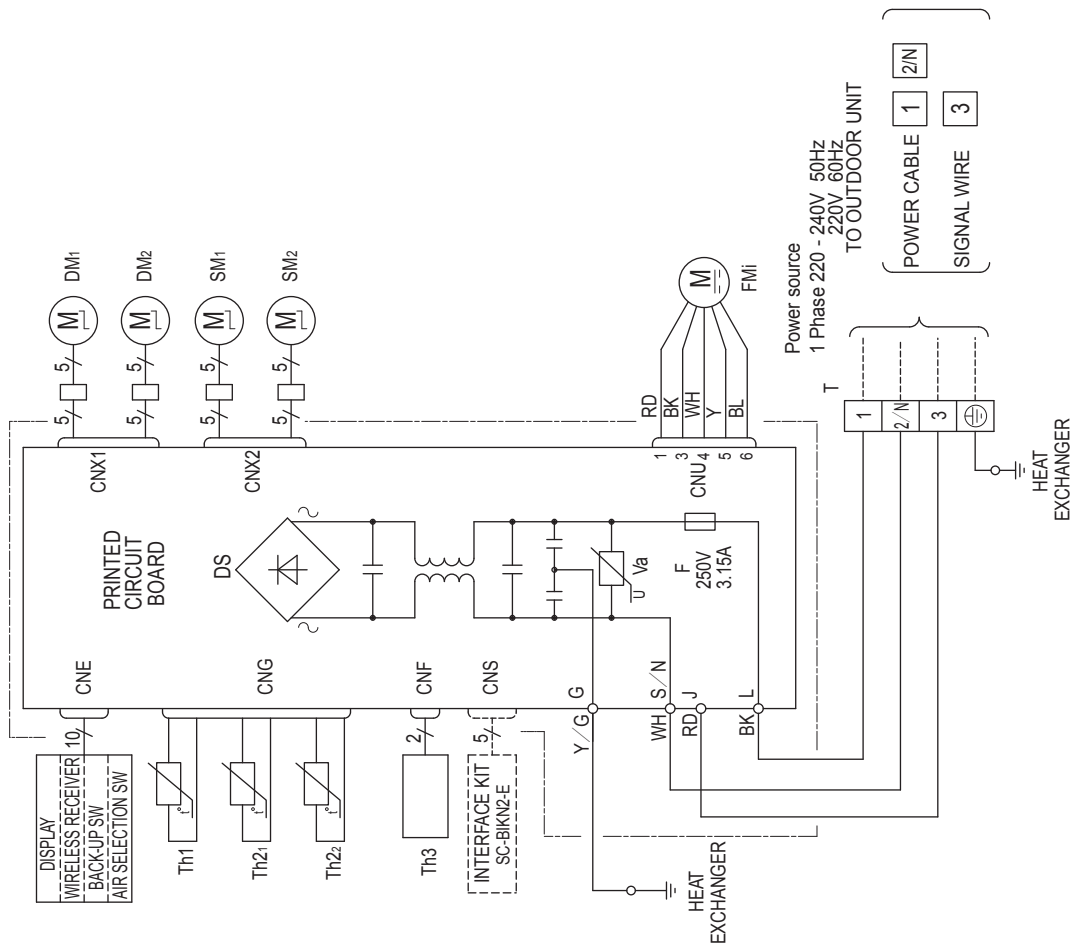

(2) Outdoor units
 Models SRC25ZS-W2, 35ZS-W2

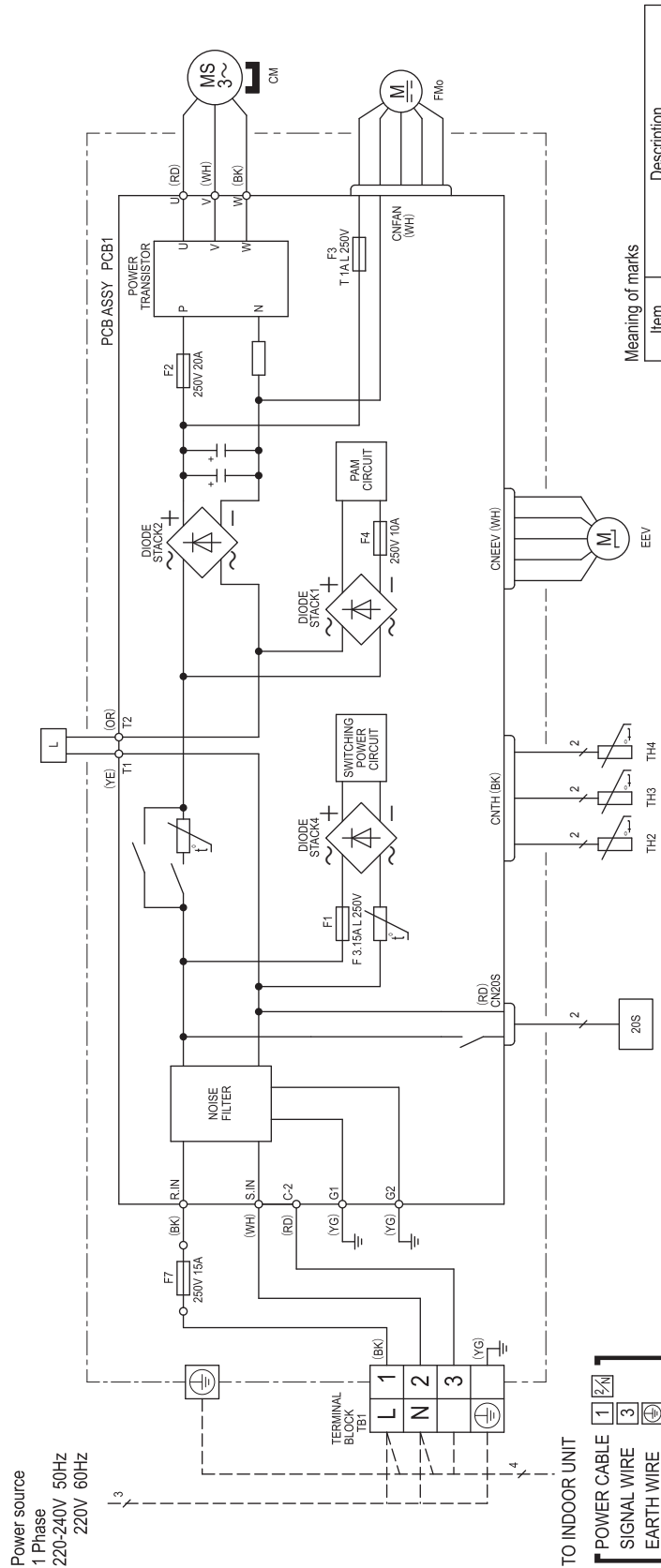

Meaning of marks

Item	Description
20S	4-way valve (coil)
CN20S	Connector
CNEEV	Compressor motor
CNFAN	Electric expansion valve (coil)
CNTH	Fan motor
CM	Reactor
EEV	Heat exchanger temperature sensor
FMo	Outdoor air temperature sensor
L	Discharge pipe temperature sensor
TH2	
TH3	
TH4	

Color marks

Mark	Color
BK	Black
RD	Red
WH	White
OR	Orange
YE	Yellow
YG	Yellow / Green

Power cable, indoor-outdoor connecting wires

Model name	MAX running current (A)	Power cable wire size x number*	Power cable length (m)	Connecting cable wire size x number*
SRC25ZS-W2	9	2.0mm ² × 3	22	1.5mm ² × 4
SRC35ZS-W2				

- * The wire numbers include earth wire (Yellow / Green).
- Switchgear or circuit breaker capacity should be chosen according to national or regional electricity regulations.
- The power cable specifications are based on the assumption that a metal or plastic conduit is used with no more than three cables contained in a conduit and a voltage drop is 2%. For an installation falling outside of these conditions, please follow the national or regional electricity regulations.

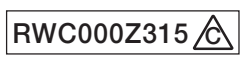

Model SRC50ZSX-W2

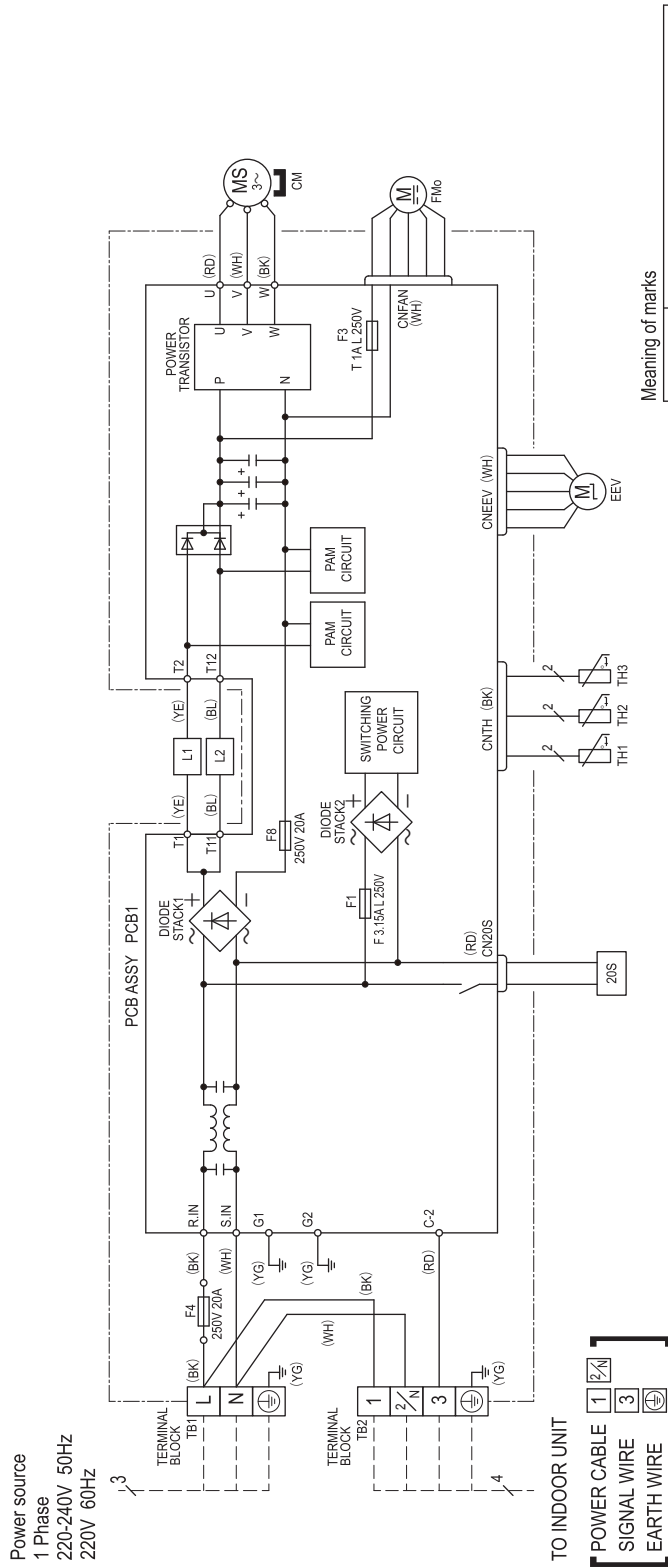

TO INDOOR UNIT
 [POWER CABLE 1 2/4]
 [SIGNAL WIRE 3]
 [EARTH WIRE]

Power cable, indoor-outdoor connecting wires

Model name	MAX running current (A)	Power cable wire size x number*	Power cable length (m)	Connecting cable wire size x number*
SRC50ZSX-W2	15	2.0mm ² x 3	13	1.5mm ² x 4

* The wire numbers include Earth wire (Yellow/Green).
 ◦ Switchgear or Circuit breaker capacity should be chosen according to national or regional electricity regulations.
 ◦ The power cable specifications are based on the assumption that a metal or plastic conduit is used with no more than three cables contained in a conduit and a voltage drop is 2%. For an installation falling outside of these conditions, please follow the national or regional electricity regulations.

Meaning of marks

Item	Description
20S	Solenoid coil for 4-way valve
CN20S	Connector
CNEEV	
CNFAN	
CNTH	
CM	Compressor motor
EEV	Electric expansion valve (coil)
FMo	Fan motor
L1,2	Reactor
TH1	Heat exchanger temperature sensor
TH2	Outdoor air temperature sensor
TH3	Discharge pipe temperature sensor

Color marks

Mark	Color
BK	Black
BL	Blue
RD	Red
WH	White
YE	Yellow
YG	Yellow/Green

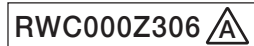

4. NOISE LEVEL

(1) Sound power level

Model SRF25ZS-W

(Indoor unit)

Model	SRF25ZS-W	
Noise Level	Cooling	50 dB(A)
	Heating	51 dB(A)

Condition	ISO5151 T1/H1
-----------	---------------

MODE	Rated capacity value (Hi)
------	---------------------------

× Cooling ○ — Heating

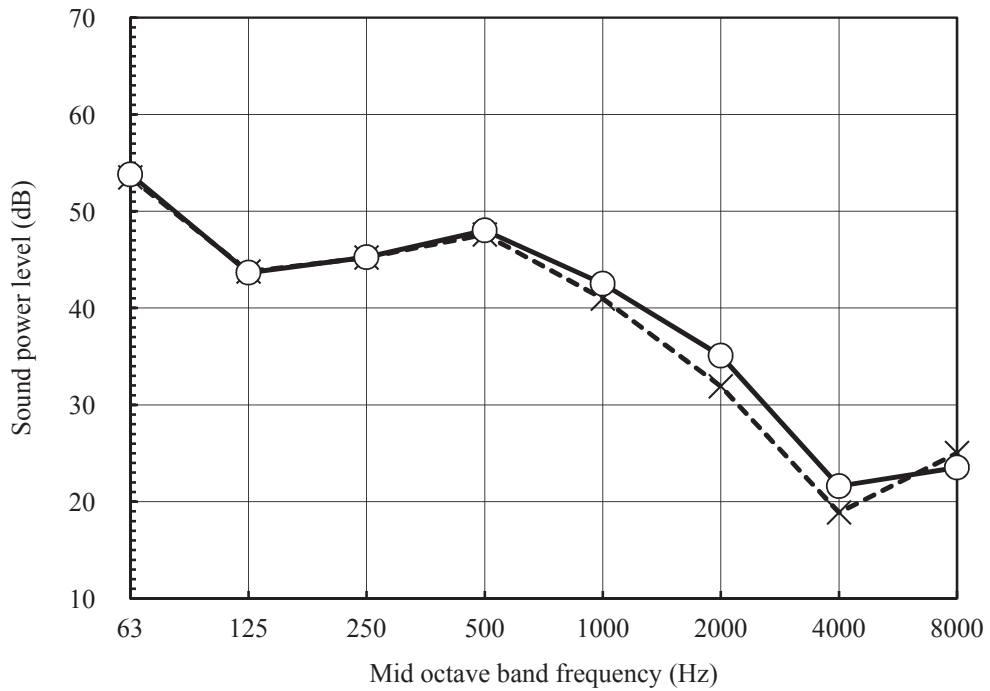

(Outdoor unit)

Model	SRC25ZS-W2	
Noise Level	Cooling	59 dB(A)
	Heating	60 dB(A)

× Cooling ○ — Heating

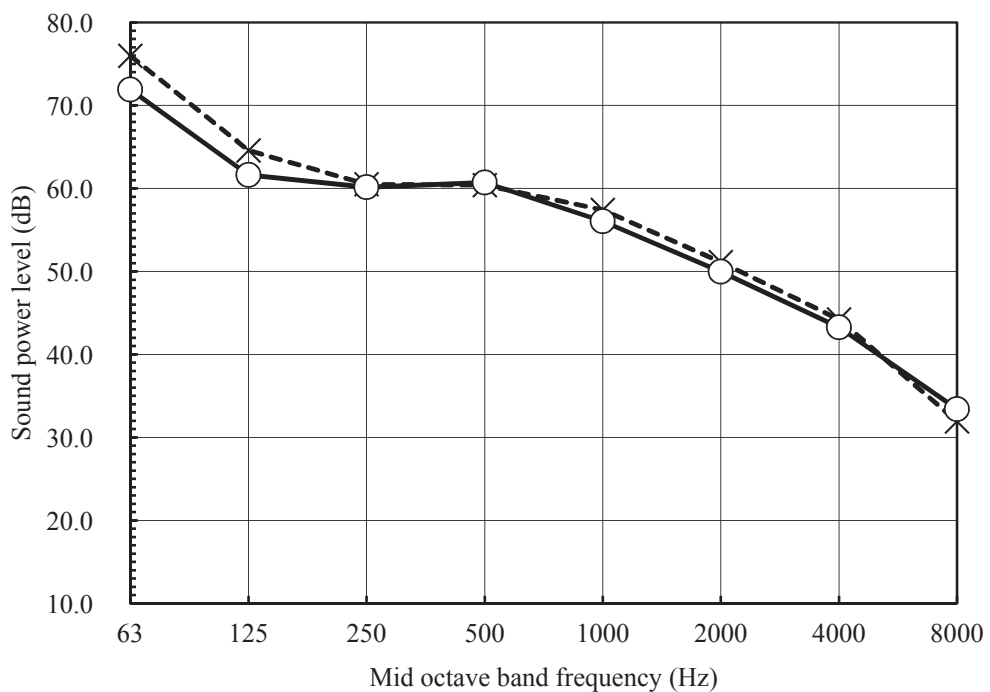

Model SRF35ZS-W

(Indoor unit)

Model	SRF35ZS-W	
Noise Level	Cooling	51 dB(A)
	Heating	52 dB(A)

Condition	ISO5151 T1/H1
-----------	---------------

MODE	Rated capacity value (Hi)
------	---------------------------

× Cooling ○ — Heating

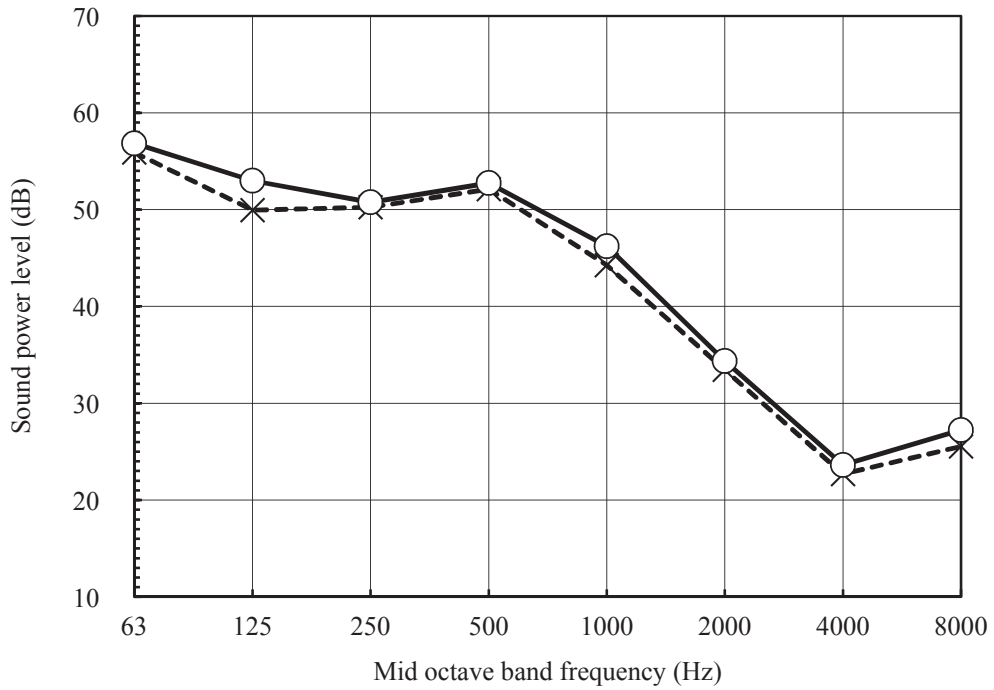

(Outdoor unit)

Model	SRC35ZS-W2	
Noise Level	Cooling	63 dB(A)
	Heating	64 dB(A)

× Cooling ○ — Heating

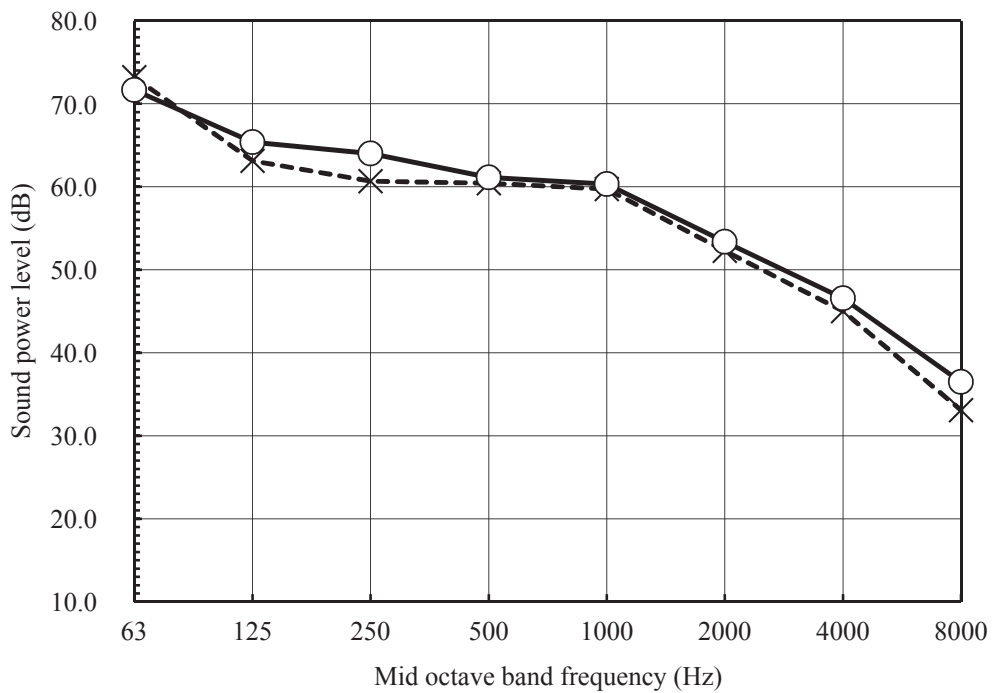

Model SRF50ZSX-W

(Indoor unit)

Model	SRF50ZSX-W	
Noise Level	Cooling	58 dB(A)
	Heating	58 dB(A)

Condition	ISO5151 T1/H1
-----------	---------------

MODE	Rated capacity value (Hi)
------	---------------------------

× Cooling ○ ——— Heating

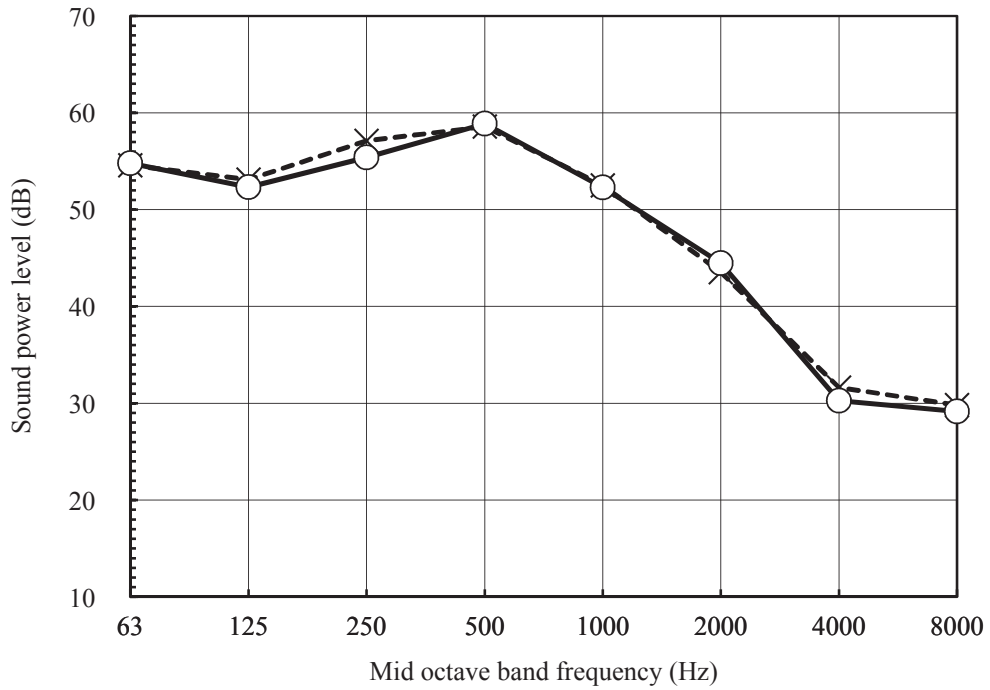

(Outdoor unit)

Model	SRC50ZSX-W2	
Noise Level	Cooling	63 dB(A)
	Heating	62 dB(A)

× Cooling ○ ——— Heating

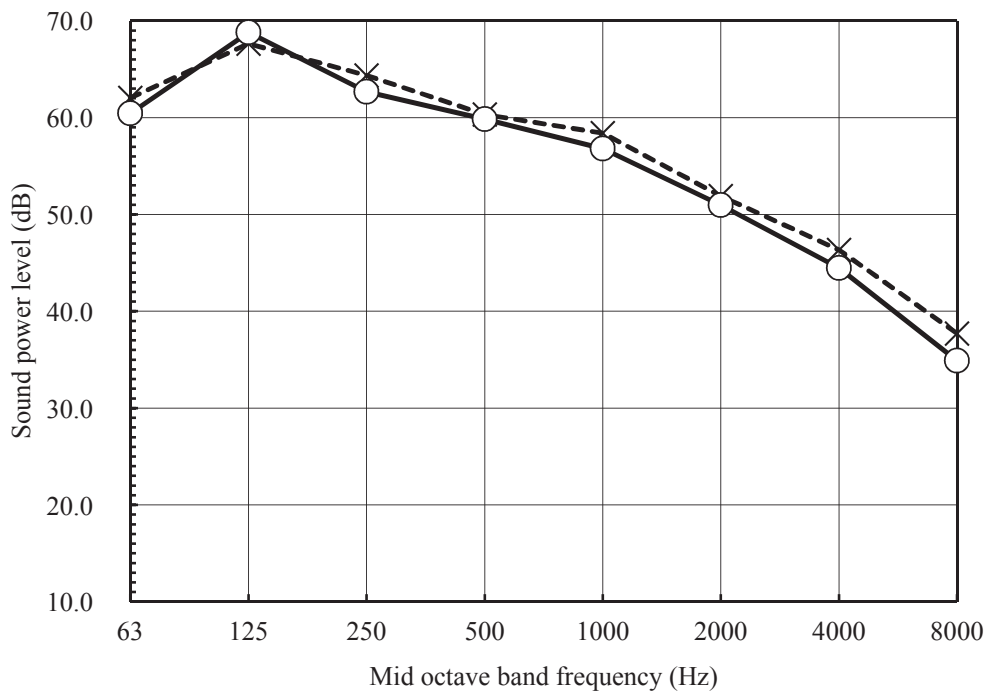

(2) Sound pressure level
 (a) Rated capacity value (Hi)
 Model SRF25ZS-W

(Indoor unit)

Model	SRF25ZS-W	
Noise Level	Cooling	38 dB(A)
	Heating	39 dB(A)

Condition	ISO5151 T1/H1
-----------	---------------

MODE	Rated capacity value (Hi)
------	---------------------------

● Mike position

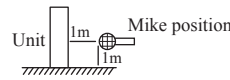

× Cooling, ○ — Heating

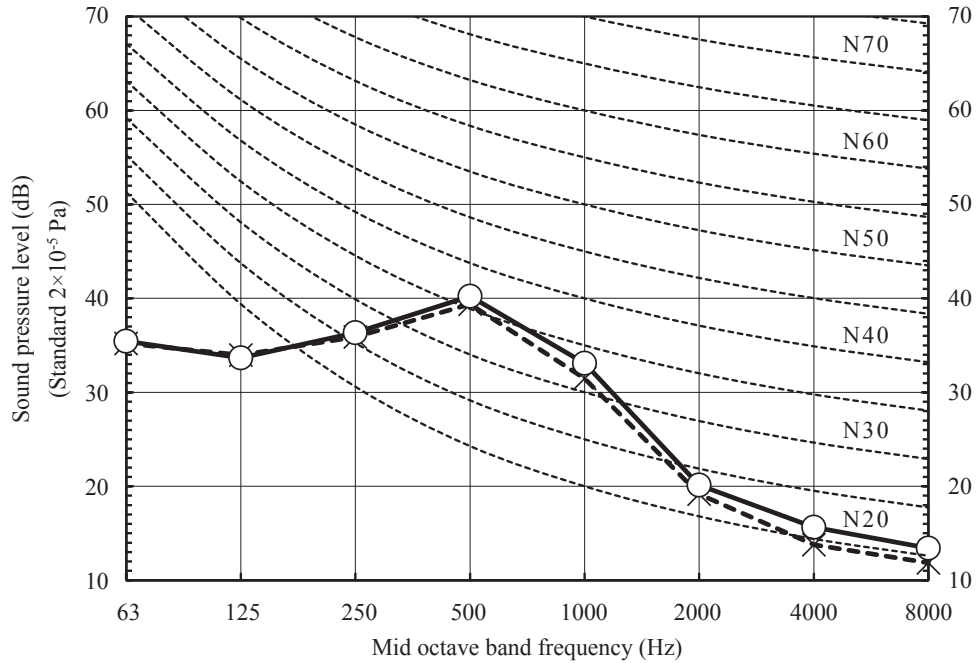

(Outdoor unit)

Model	SRC25ZS-W2	
Noise Level	Cooling	45 dB(A)
	Heating	47 dB(A)

● Mike position: at highest noise level in position as mentioned below
 Distance from front side 1m

× Cooling, ○ — Heating

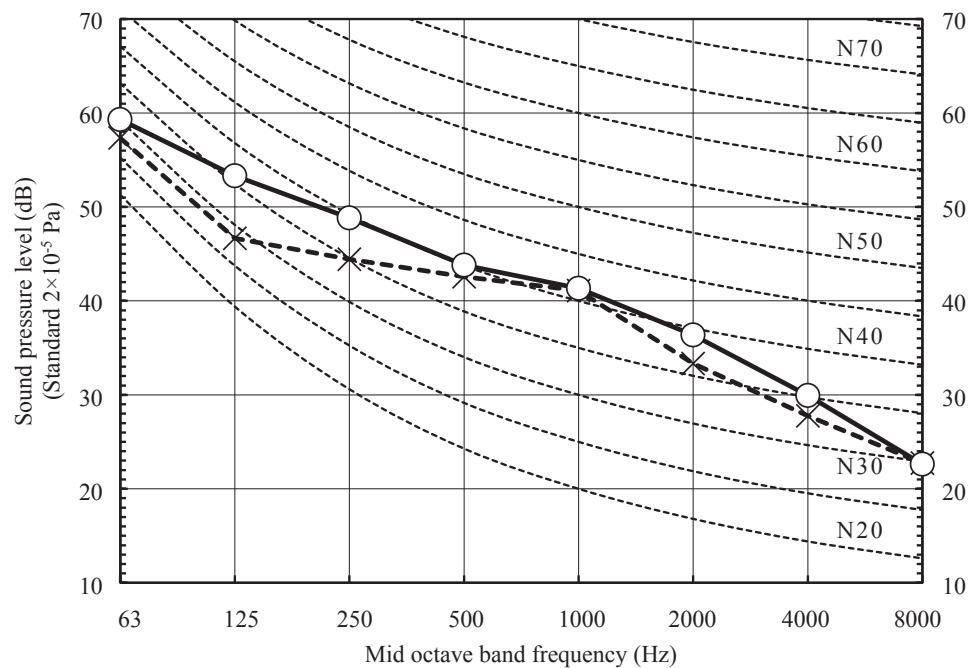

Model SRF35ZS-W

Condition	ISO5151 T1/H1
-----------	---------------

MODE	Rated capacity value (Hi)
------	---------------------------

(Indoor unit)

Model	SRF35ZS-W	
Noise Level	Cooling	40 dB(A)
	Heating	41 dB(A)

●Mike position

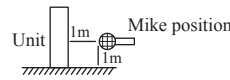

× Cooling, ○ — Heating

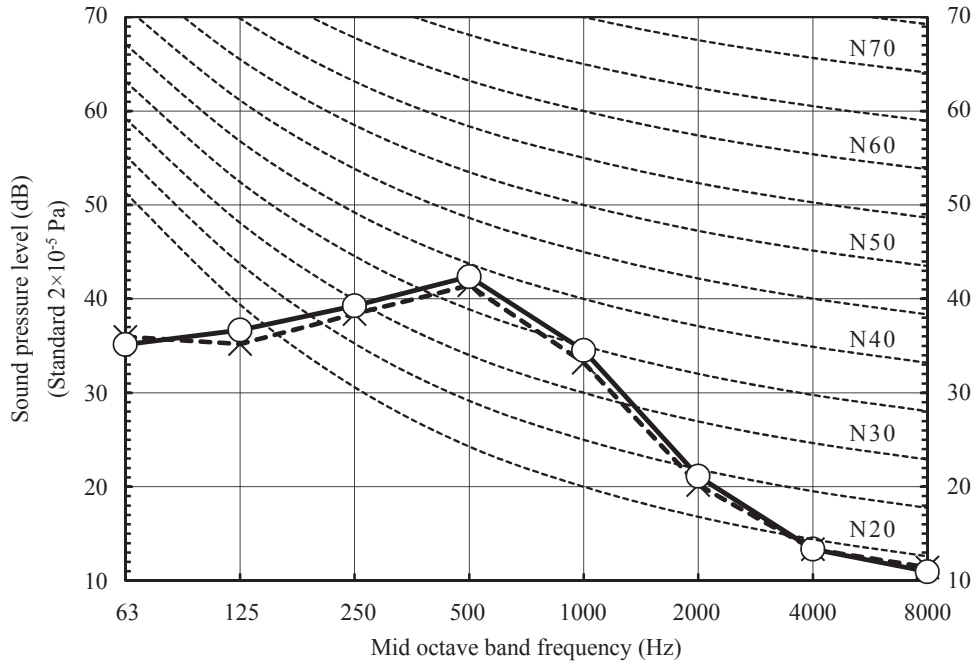

(Outdoor unit)

Model	SRC35ZS-W2	
Noise Level	Cooling	50 dB(A)
	Heating	51 dB(A)

●Mike position: at highest noise level in position as mentioned below
Distance from front side 1m

× Cooling, ○ — Heating

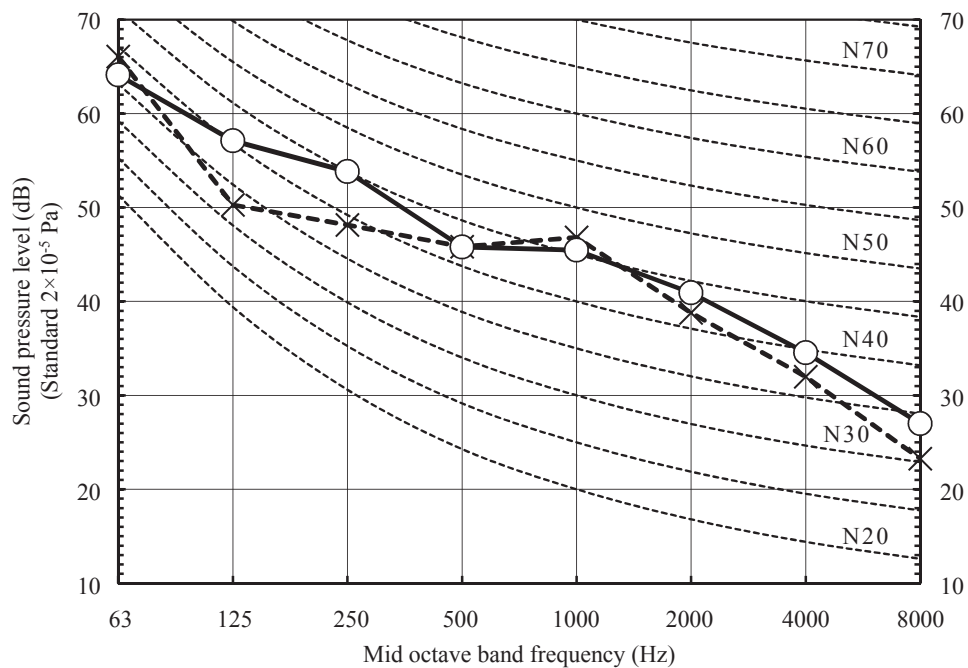

Model SRF50ZSX-W

Condition	ISO5151 T1/H1
MODE	Rated capacity value (Hi)

(Indoor unit)

Model	SRF50ZSX-W	
Noise Level	Cooling	46 dB(A)
	Heating	46 dB(A)

●Mike position

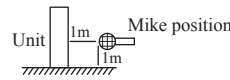

× Cooling, ○ — Heating

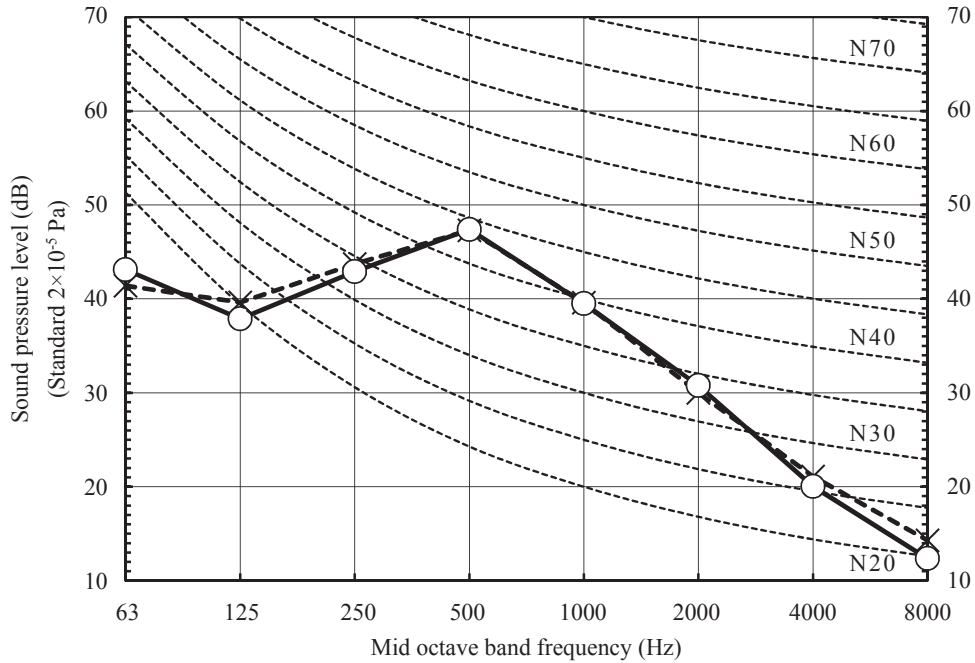

(Outdoor unit)

Model	SRC50ZSX-W2	
Noise Level	Cooling	51 dB(A)
	Heating	51 dB(A)

●Mike position: at highest noise level in position as mentioned below
Distance from front side 1m

× Cooling, ○ — Heating

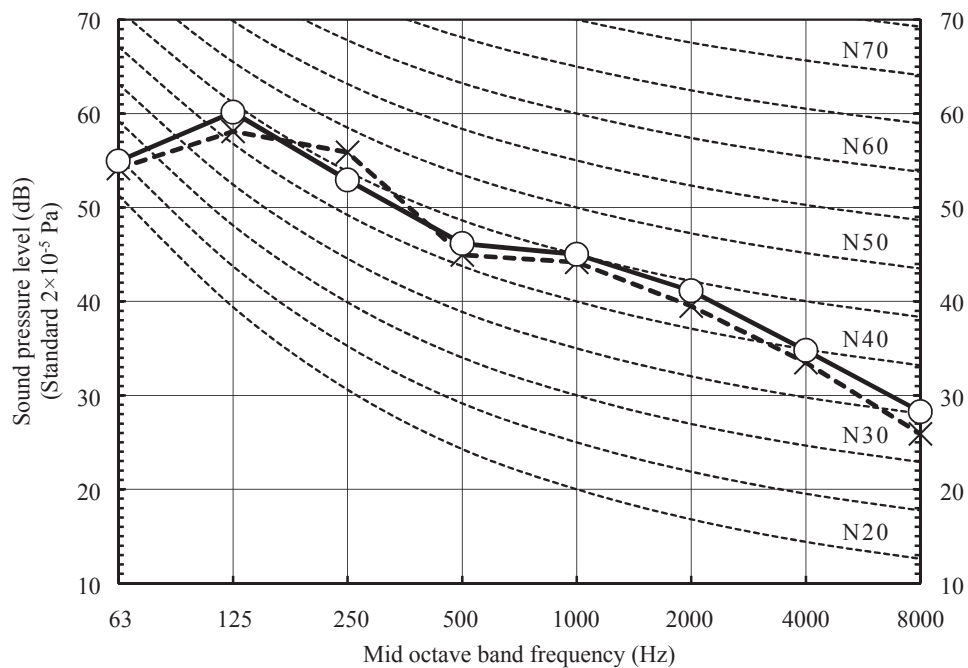

**(b)Each fan speed mode
Model SRF25ZS-W**

Condition	ISO5151 T1/H1
-----------	---------------

MODE	Me
------	----

(Indoor unit)

Model	SRF25ZS-W	
Noise Level	Cooling	32 dB(A)
	Heating	35 dB(A)

●Mike position

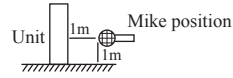

× Cooling, ○ — Heating

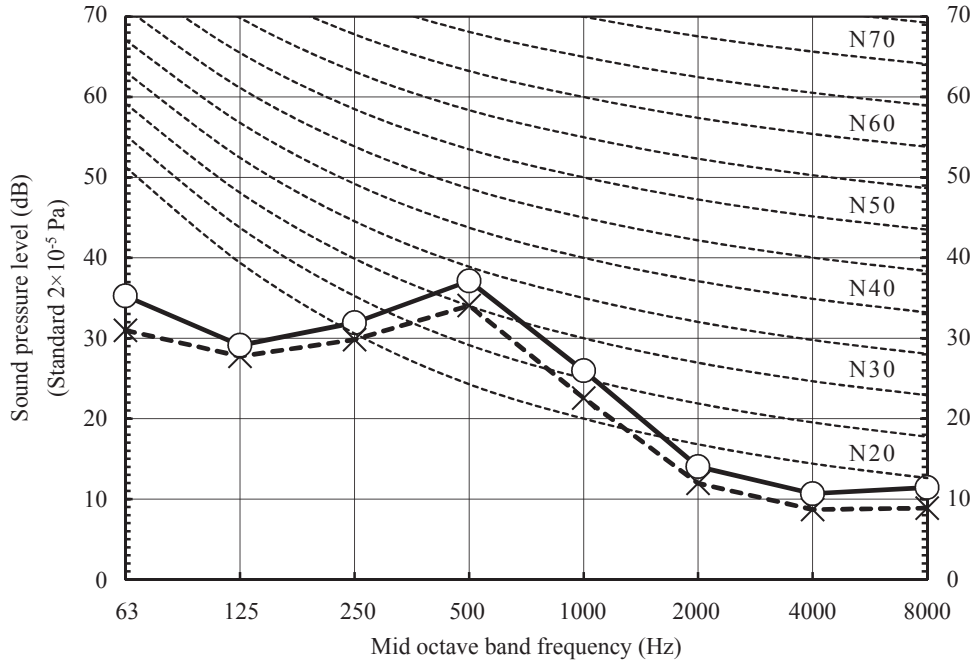

Condition	ISO5151 T1/H1
-----------	---------------

MODE	Lo
------	----

(Indoor unit)

Model	SRF25ZS-W	
Noise Level	Cooling	29 dB(A)
	Heating	33 dB(A)

●Mike position

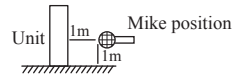

× Cooling, ○ — Heating

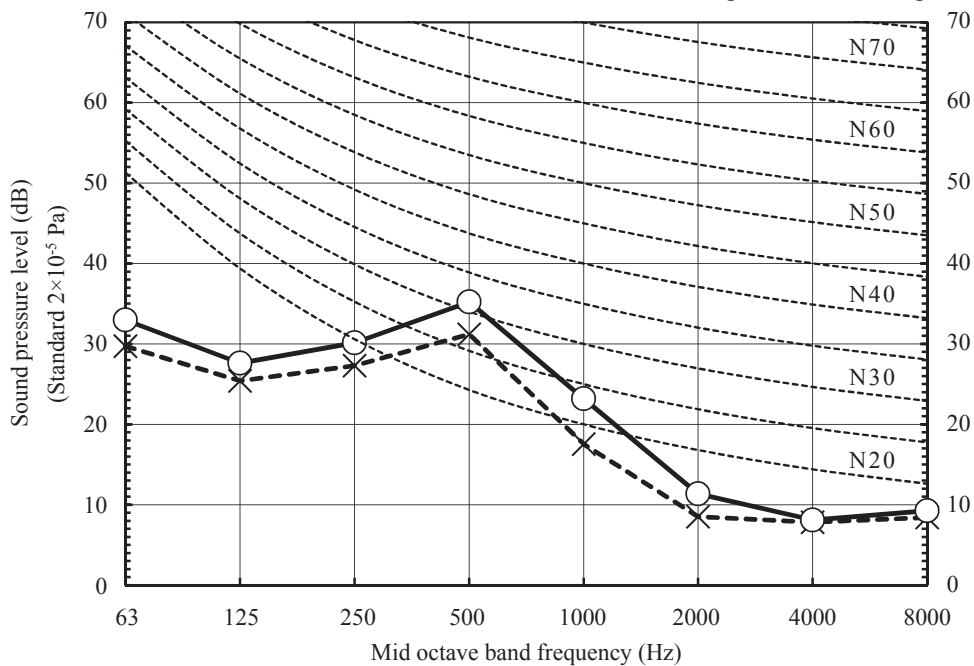

(Indoor unit)

Model	SRF25ZS-W	
Noise Level	Cooling	25 dB(A)
	Heating	29 dB(A)

Condition	ISO5151 T1/H1
-----------	---------------

MODE	ULo
------	-----

●Mike position

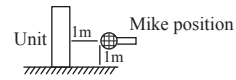

× Cooling, ○ — Heating

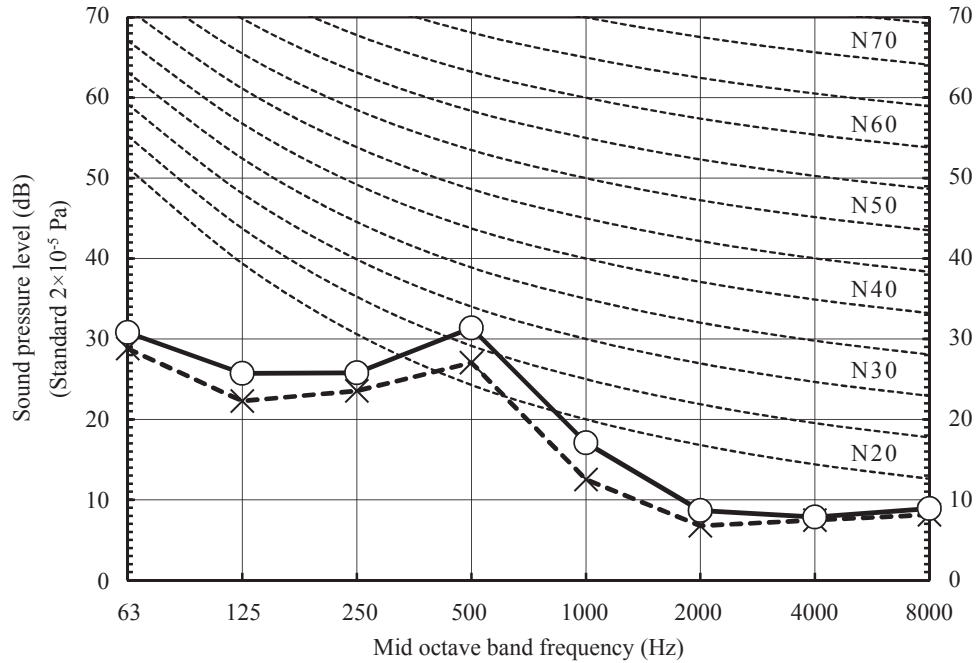

(Outdoor unit)

Model	SRC25ZS-W2	
Noise Level	Cooling	41 dB(A)
	Heating	42 dB(A)

Condition	ISO5151 T1/H1
-----------	---------------

MODE	Silent
------	--------

× Cooling, ○ — Heating

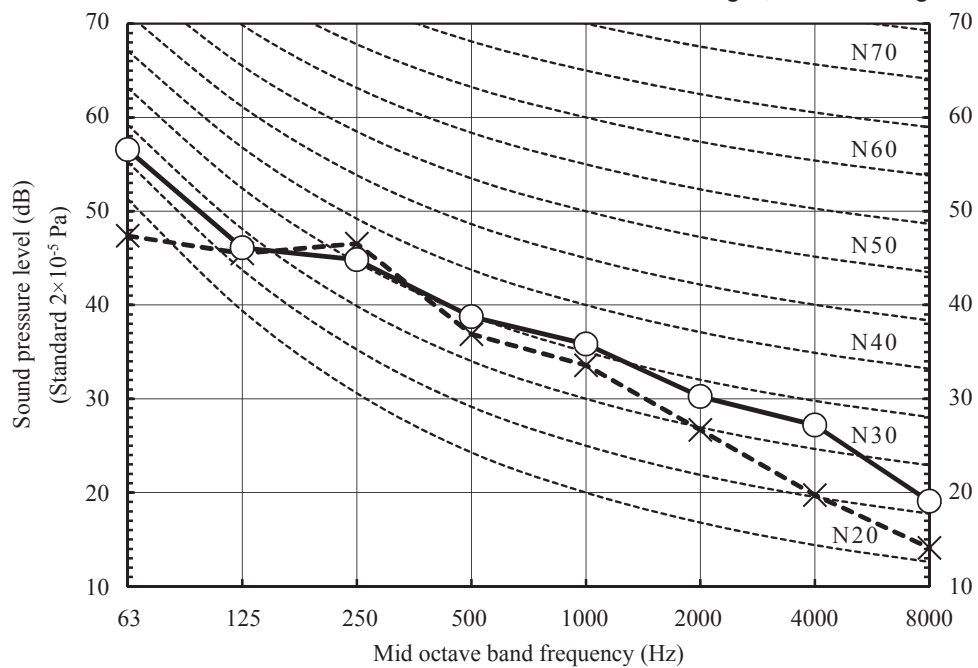

Model SRF35ZS-W

Condition	ISO5151 T1/H1
-----------	---------------

MODE	Me
------	----

(Indoor unit)

Model	SRF35ZS-W	
Noise Level	Cooling	35 dB(A)
	Heating	36 dB(A)

●Mike position

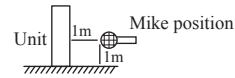

× Cooling, ○ — Heating

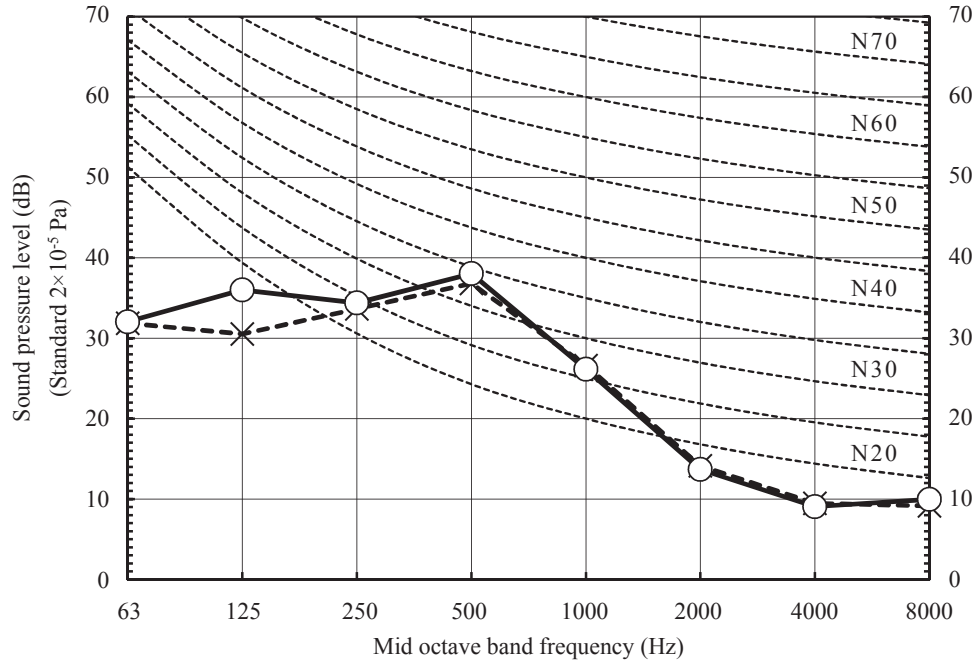

Condition	ISO5151 T1/H1
-----------	---------------

MODE	Lo
------	----

(Indoor unit)

Model	SRF35ZS-W	
Noise Level	Cooling	33 dB(A)
	Heating	35 dB(A)

●Mike position

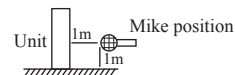

× Cooling, ○ — Heating

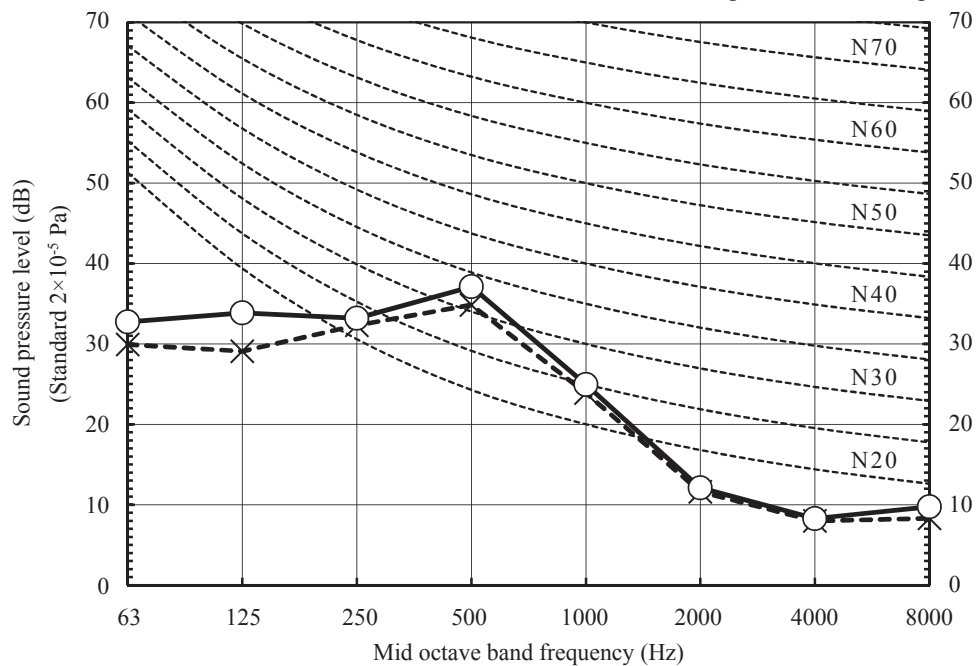

(Indoor unit)

Model	SRF35ZS-W	
Noise Level	Cooling	29 dB(A)
	Heating	33 dB(A)

Condition	ISO5151 T1/H1
-----------	---------------

MODE	ULo
------	-----

●Mike position

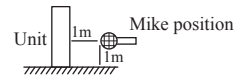

× Cooling, ○ — Heating

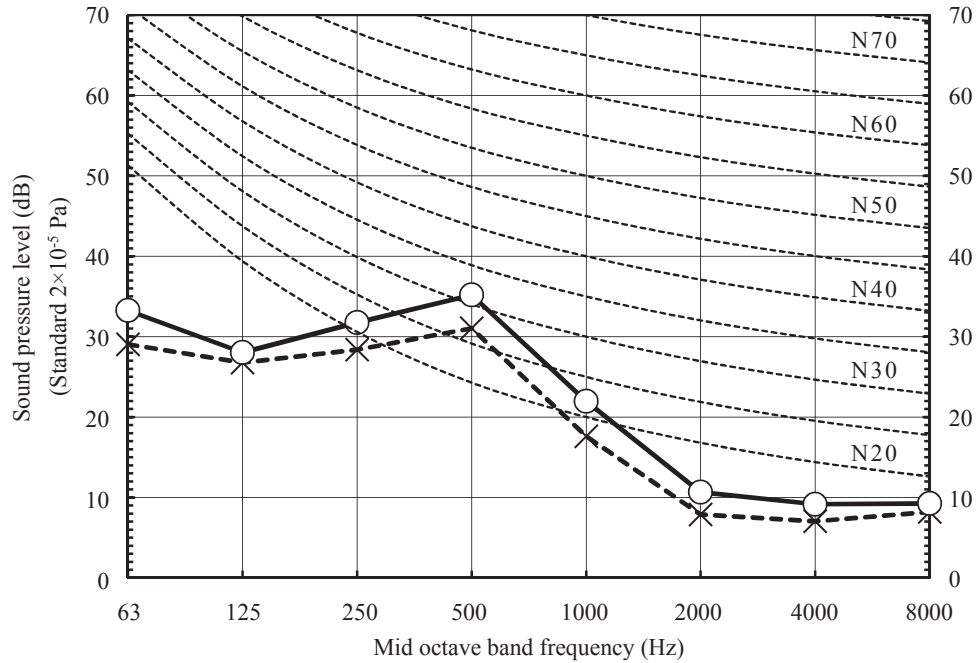

(Outdoor unit)

Model	SRC35ZS-W2	
Noise Level	Cooling	44 dB(A)
	Heating	43 dB(A)

Condition	ISO5151 T1/H1
-----------	---------------

MODE	Silent
------	--------

× Cooling, ○ — Heating

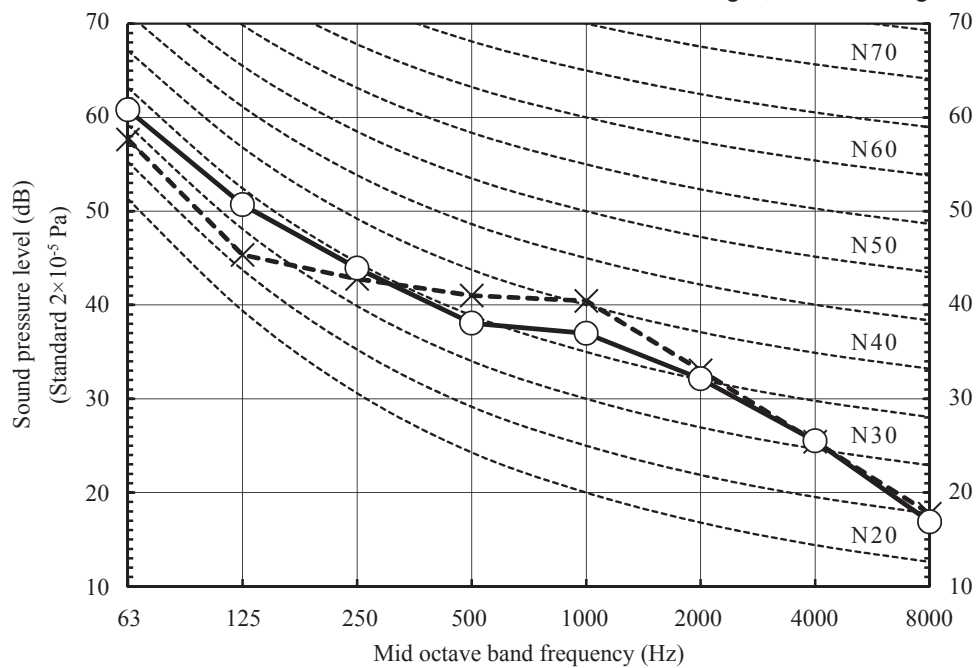

Model SRF50ZSX-W

(Indoor unit)

Model	SRF50ZSX-W	
Noise Level	Cooling	38 dB(A)
	Heating	41 dB(A)

Condition	ISO5151 T1/H1
-----------	---------------

MODE	Me
------	----

●Mike position

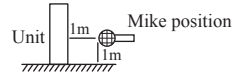

× Cooling, ○ — Heating

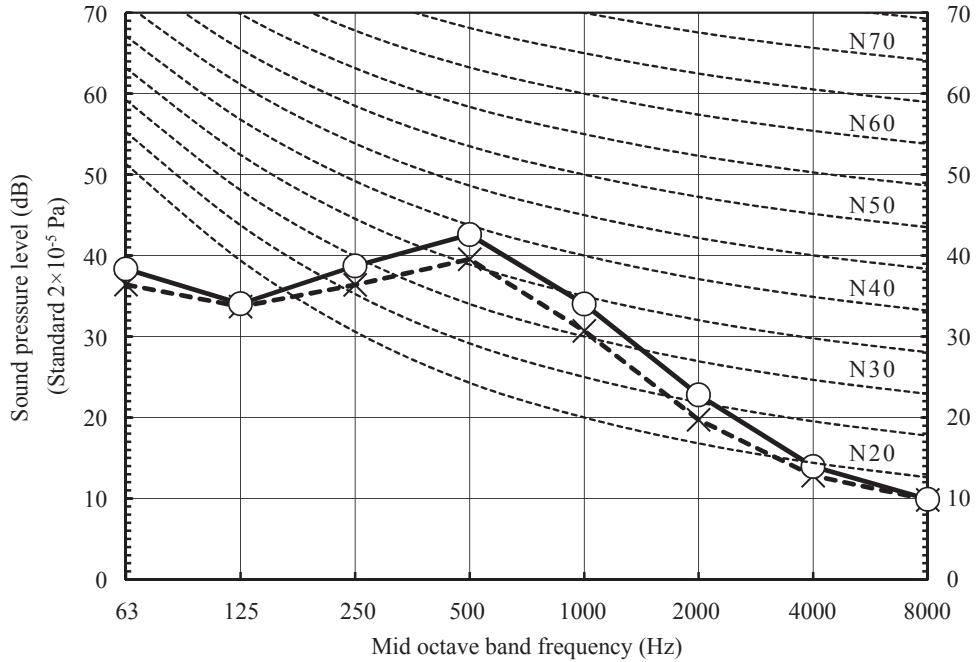

(Indoor unit)

Model	SRF50ZSX-W	
Noise Level	Cooling	33 dB(A)
	Heating	38 dB(A)

Condition	ISO5151 T1/H1
-----------	---------------

MODE	Lo
------	----

●Mike position

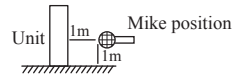

× Cooling, ○ — Heating

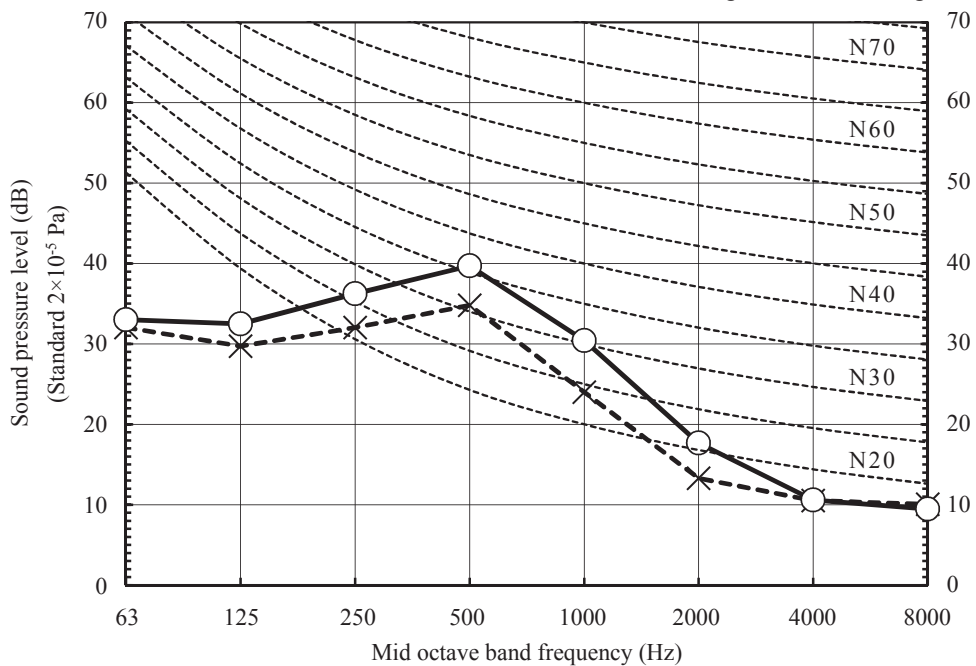

(Indoor unit)

Model	SRF50ZSX-W	
Noise Level	Cooling	28 dB(A)
	Heating	32 dB(A)

Condition	ISO5151 T1/H1
-----------	---------------

MODE	ULo
------	-----

●Mike position

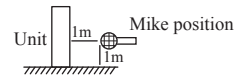

× Cooling, ○ — Heating

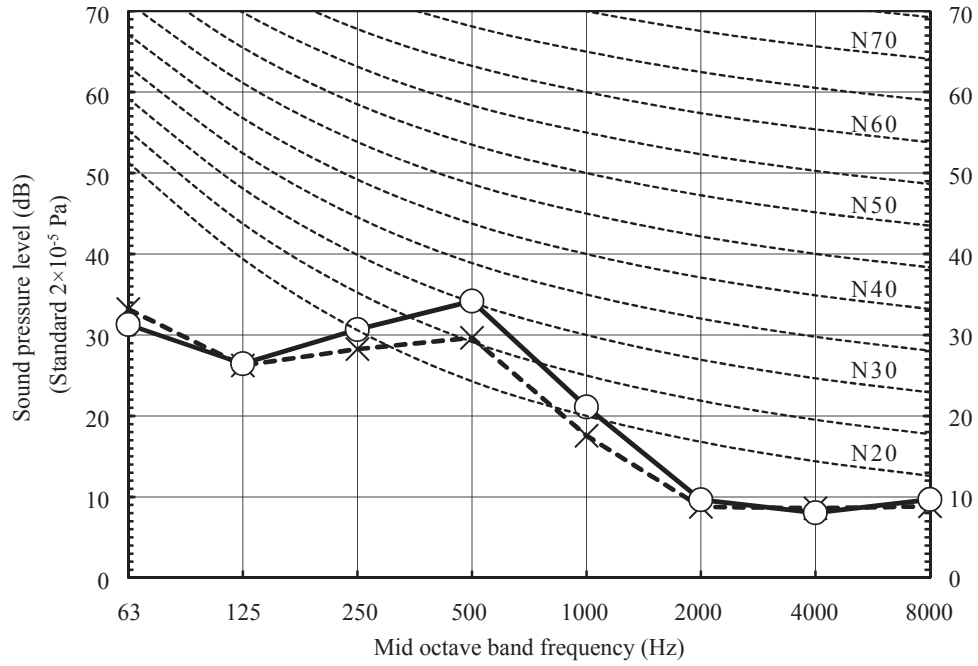

(Outdoor unit)

Model	SRC50ZSX-W2	
Noise Level	Cooling	42 dB(A)
	Heating	43 dB(A)

Condition	ISO5151 T1/H1
-----------	---------------

MODE	Silent
------	--------

× Cooling, ○ — Heating

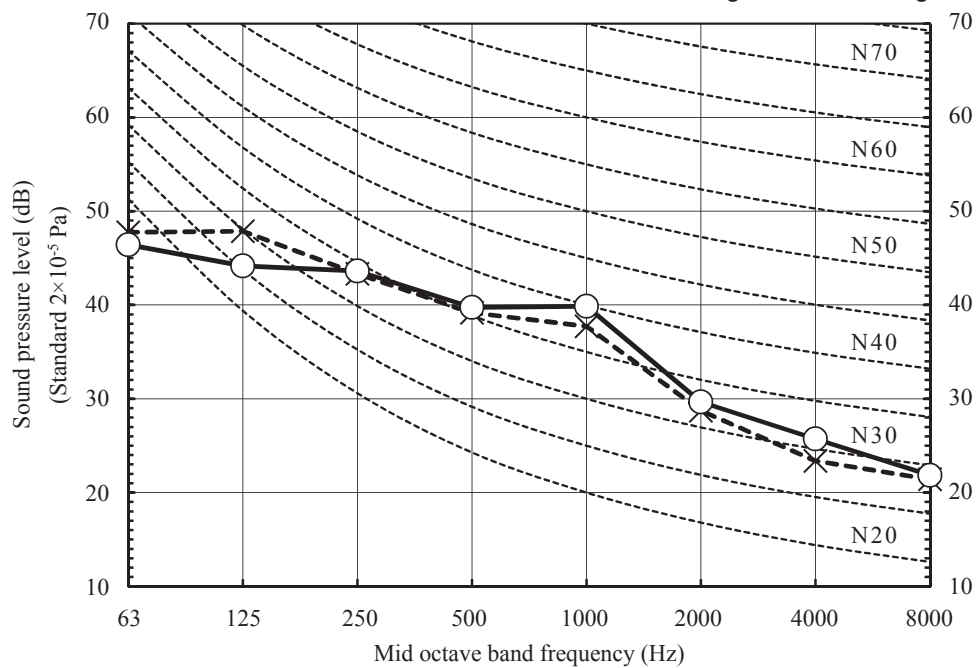

5. PIPING SYSTEM

Models SRF25ZS-W, 35ZS-W

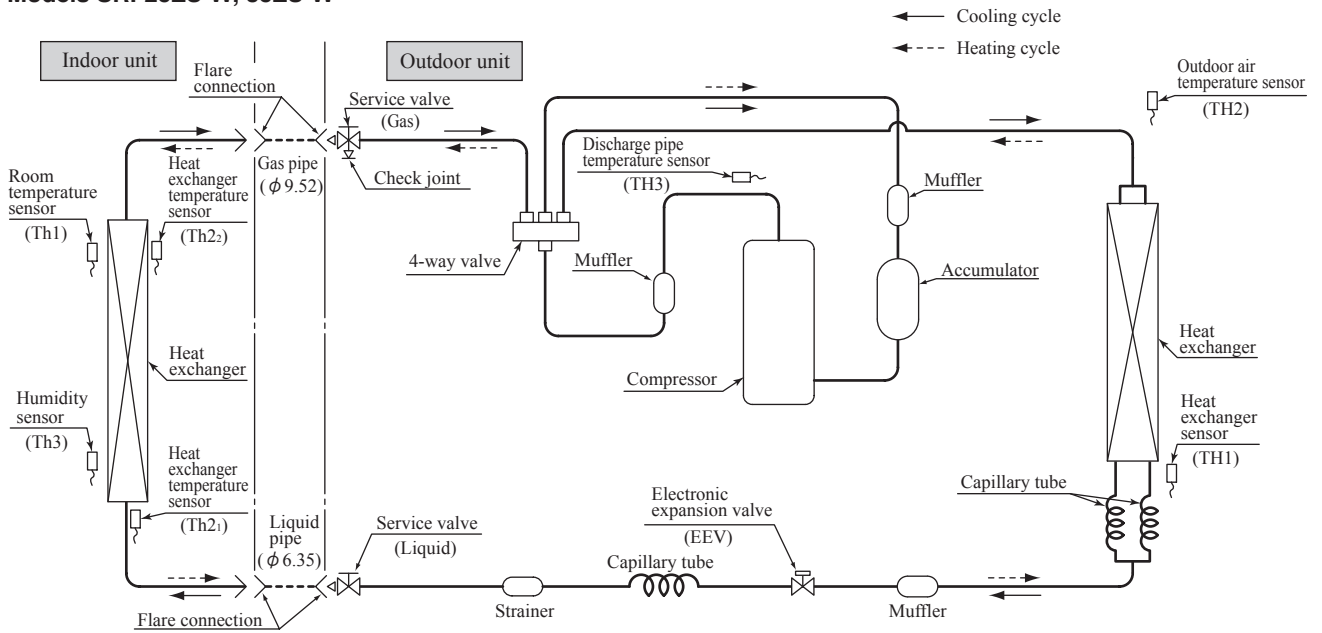

Model SRF50ZSX-W

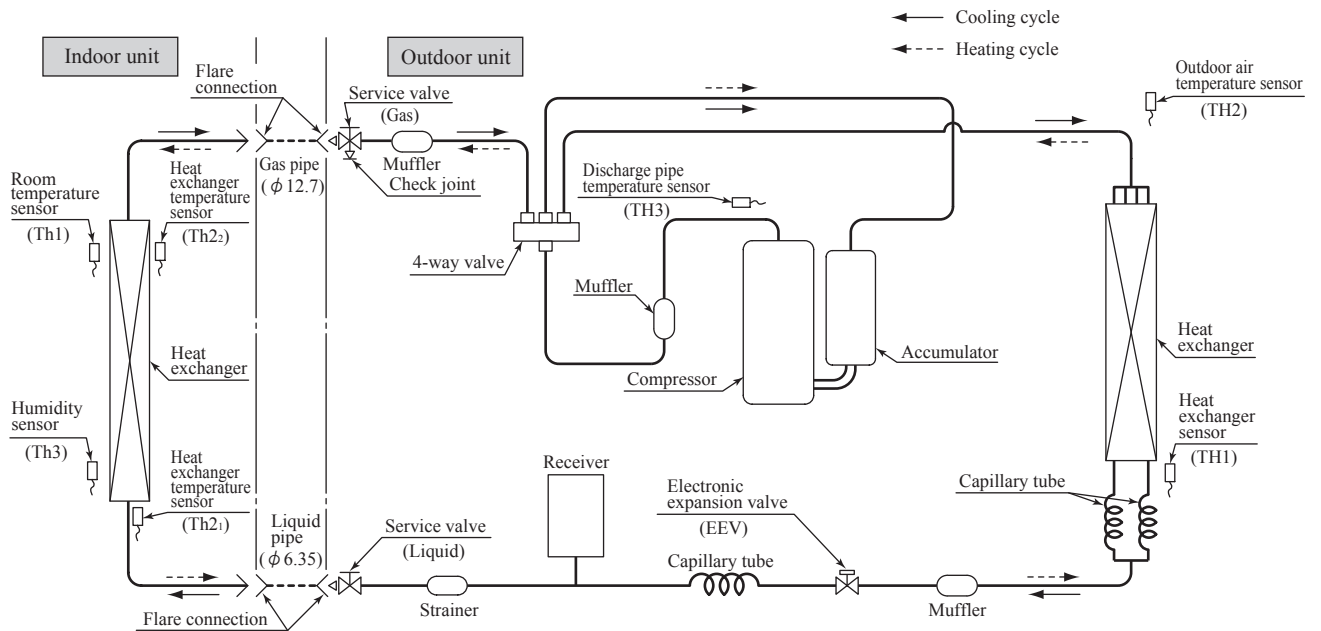

6. RANGE OF USAGE & LIMITATIONS

Model	SRF25ZS-W SRF35ZS-W	SRF50ZSX-W
Item		
Indoor return air temperature (Upper, lower limits)	Cooling operation : Approximately 18 to 32°C DB Heating operation : Approximately 10 to 30°C DB (Refer to the selection chart)	
Outdoor air temperature (Upper, lower limits)	Cooling operation : Approximately -15 to 46°C DB Heating operation : Approximately -15 to 24°C DB (Refer to the selection chart)	
Refrigerant line (one way) length	Max. 20m	Max. 30m
Vertical height difference between outdoor unit and indoor unit	Max. 10m (Outdoor unit is higher) Max. 10m (Outdoor unit is lower)	Max. 20m (Outdoor unit is higher) Max. 20m (Outdoor unit is lower)
Power source voltage	Rating ± 10%	
Voltage at starting	Min. 85% of rating	
Frequency of ON-OFF cycle	Max. 4 times/h (Inching prevention 10 minutes)	
ON and OFF interval	Min. 3 minutes	

Selection chart

Correct the cooling and heating capacity in accordance with the conditions as follows. The net cooling and heating capacity can be obtained in the following way.

Net capacity = Capacity shown on specification × Correction factors as follows

(1) Coefficient of cooling and heating capacity in relation to temperatures

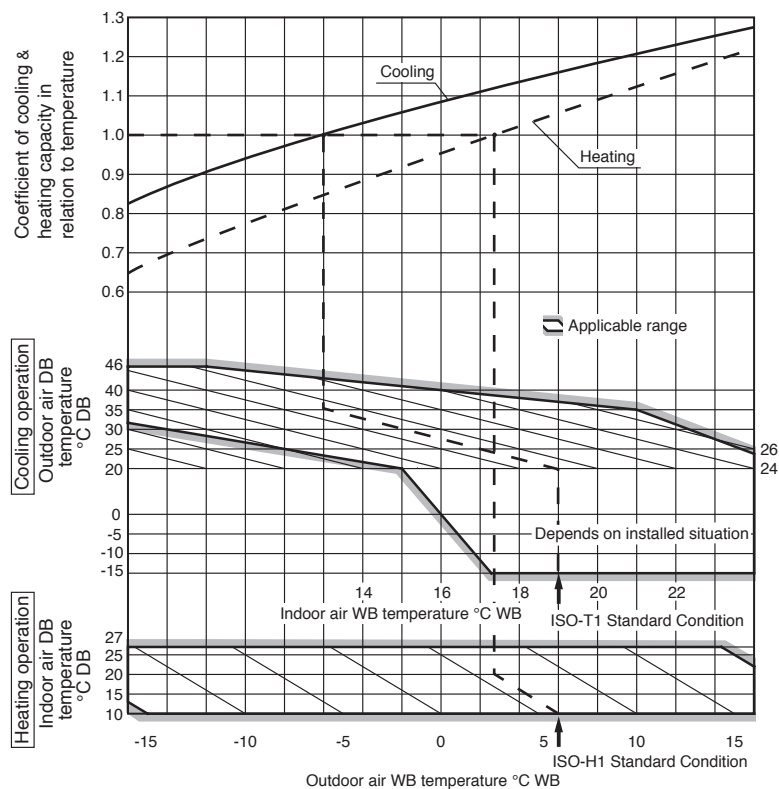

(2) Correction of cooling and heating capacity in relation to one way length of refrigerant piping

It is necessary to correct the cooling and heating capacity in relation to the one way piping length between the indoor and outdoor units.

Piping length [m]	7	10	15	20	25	30
Cooling	1.0	0.99	0.975	0.965	0.95	0.935
Heating	1.0	1.0	1.0	1.0	1.0	1.0

(3) Correction relative to frosting on outdoor heat exchanger during heating

In additions to the foregoing corrections (1), (2) the heating capacity needs to be adjusted also with respect to the frosting on the outdoor heat exchanger.

Air inlet temperature of outdoor unit in °CWB	-15	-10	-9	-7	-5	-3	-1	1	3	5 or more
Adjustment coefficient	0.95	0.95	0.94	0.93	0.91	0.88	0.86	0.87	0.92	1.00

How to obtain the cooling and heating capacity

Example : The net cooling capacity of the model SRF35ZS-W with the piping length of 15m, indoor wet-bulb temperature at 19.0°C and outdoor dry-bulb temperature 35°C is

$$\text{Net cooling capacity} = \frac{3.5}{\text{SRF35ZS-W}} \times \frac{0.975}{\text{Length 15m}} \times \frac{1.0}{\text{Factor by air temperatures}} \approx 3.4 \text{ kW}$$

8. APPLICATION DATA

(1) Installation of indoor unit Models SRF25ZS-W, 35ZS-W, 50ZSX-W

CAUTION
<ul style="list-style-type: none"> Carry out the electrical work for ground lead with care. Do not connect the ground lead to the gas line, water line, lightning conductor or telephone line's ground lead. Incorrect grounding can cause unit faults such as electric shocks due to short-circuiting. Use the circuit breaker of correct capacity. Circuit breaker should be able to disconnect all poles under over current. Using the incorrect one could cause the system failure and fire. Install isolator or disconnect switch on the power source wiring in accordance with the local codes and regulations. The isolator should be locked in OFF state in accordance with EN60204-1. Be sure to install indoor unit properly according to instruction manual so that drainage can run off smoothly. Improper installation of indoor unit can cause dropping water into the room and damaging personal property. Install the drainage pipe to run off drainage securely according to the installation manual. Incorrect installation of the drainage pipe can cause dropping water into the room and damaging personal property. Be sure to install the drainage pipe with descending slope of 1/100 or more, and not to make traps and air-bleedings. Check if the drainage runs off securely during commissioning and ensure the space for inspection and maintenance. After maintenance, all wiring, wiring ties and the like, should be returned to their original state and wiring route, and the necessary clearance from all metal parts should be secured. Secure a space for installation, inspection and maintenance specified in the manual. Insufficient space can result in accident such as personal injury due to falling from the installation place. Take care when carrying the unit by hand. If the unit weighs more than 20 kg, it must be carried by two or more persons. Do not carry by the plastic straps. Always use the carry handle.
<ul style="list-style-type: none"> Do not install the unit in the locations listed below. <ul style="list-style-type: none"> Locations where carbon fiber, metal powder or any powder is floating. Locations where any substances that can affect the unit such as sulphide gas, chloride gas, acid and alkali can occur. Vehicles and ships. Locations where cosmetic or special sprays are often used. Locations with direct exposure of oil mist and steam such as kitchen and machine plant. Locations where any machines which generate high frequency harmonics are used. Locations with salty atmospheres such as coastlines. Locations with heavy snow. If installed, be sure to provide base flame and snow hood mentioned in the manual. Locations where the unit is exposed to chimney smoke. Locations with high altitude (more than 1000 m high). Locations with ammoniac atmospheres (e.g. organic fertilizer). Locations with calcium chloride (e.g. snow melting agent). Locations where heat radiation from other heat source can affect the unit. Locations without good air circulation. Locations with any obstacles which can prevent inlet and outlet air of the unit. Locations where short-circuit of air can occur (in case of multiple units installation). Locations where strong air blows against the air outlet of outdoor unit. Locations where something located above the unit could fall. It can cause remarkable decrease in performance, corrosion and damage of components, malfunction and fire. Do not install the indoor unit in the locations listed below (Be sure to install the indoor unit according to the installation manual for each model because each indoor unit has each limitation). <ul style="list-style-type: none"> Locations with any obstacles which can prevent inlet and outlet air of the unit. Locations where vibration can be amplified due to insufficient strength of structure. Locations where the infrared receiver is exposed to the direct sunlight or the strong light beam (in case of the infrared specification unit). Set or radio receiver is placed within 1 m). Locations where drainage cannot run off safely. It can affect performance and function and etc. Do not install the unit near the location where leakage of combustible gases can occur. If leaked gases accumulate around the unit, it can cause fire.
<ul style="list-style-type: none"> Do not install the unit where corrosive gas (such as sulfuric acid gas etc.) or combustible gas (such as thinner and petroleum gas etc.) can accumulate or collect, or where volatile combustible substances are handled. Corrosive gas can cause corrosion of heat exchanger, breakage of plastic parts and etc. And combustible gas can cause fire. Do not use the indoor unit at the place where water splashes may occur such as in bathrooms. Since the indoor unit is not waterproof, it can cause electric shocks and fire. Do not install nor use the system close to the equipment that generates electromagnetic fields or high frequency harmonics. Equipments such as inverters, standby generators, medical high frequency equipments and telecom multation equipments can affect the system, and cause malfunctions and breakdowns. The system can also affect medical equipment and telecommunication equipment, and obstruct its function or cause jamming. Do not place any variables which will be damaged by getting wet. When the relative humidity is higher than 80 % or drainage pipe is clogged, condensation or drainage water can drop and it can cause the damage of valves. Do not install the remote control at the direct sunlight. It can cause malfunction or deformation of the remote control. Do not use the unit for special purposes such as storing loads, cooling precision instruments and preservation of animals, plants or art. Do not use any materials other than a fuse with the correct rating in the location where fuses are to be used. Connecting the circuit with copper wire or other metal thread can cause unit failure and fire. Do not touch any buttons with wet hands. It can cause electric shocks. Do not touch any refrigerant pipes with your hands when the system is in operation. During operation the refrigerant pipes become extremely hot or extremely cold depending on the operating condition, and it can cause burn injury or frost injury. Do not wash the inside of the air-conditioner. Water leakage and permanent damage may result. Electrical hazard exists.

WARNING
<ul style="list-style-type: none"> A wired remote control unit is supplied separately as an option part. When install the unit, be sure to check whether the selection of installation place, power source specifications, usage limitation (piping length, height differences between indoor and outdoor units, power source voltage and etc.) and installation spaces. Keep the installation manual together with user's manual at a place where any user can read at any time. Moreover if necessary, ask to hand them to a new user. Before starting the installation work, proper precautions (using suitable protective clothing, gloves etc.) should be taken by qualified installer. Pay attention not to fall down the tools, etc. when installing the unit at the high position. If unusual noise can be heard during operation, consult the dealer. The meanings of "Marks" used here are shown as follows: <ul style="list-style-type: none"> Never do it under any circumstances. Always do it according to the instruction.
<ul style="list-style-type: none"> Installation must be carried out by the qualified installer. If you install the system by yourself, it may cause serious trouble such as water leaks, electric shocks, fire and personal injury, as a result of a system malfunction. Do not carry out the installation and maintenance work except the by qualified installer. Install the system in full accordance with the installation manual. Incorrect installation may cause burns, personal injury, water leaks, electric shocks and fire. Be sure to use only for household and residence. Since this appliance is installed in inferior environment such as machine shop and etc., it can cause malfunction. Use the original accessories and the specified components for installation. If parts other than those prescribed by us are used, it may cause water leaks, electric shocks, fire and personal injury. Install the unit in a location with good support. Unsuitable installation locations can cause the unit to fall resulting in material damage and personal injury. Ventilate the working area well in the event of refrigerant leakage during installation. If the refrigerant comes into contact with naked flames, poisonous gas is produced. When installing in small rooms, take prevention measures not to exceed the density limit of refrigerance in the event of leakage, referred by the formula (accordance with ISO5149). If the density of refrigerant exceeds the limit, consult the dealer and install the ventilation system, otherwise lack of oxygen can occur, which can cause serious accident. After completing installation, check that no refrigerant leaks from the system. If refrigerant leaks into the room and comes into contact with an oven or other hot surface, poisonous gas is produced. Use the prescribed pipes, flare nuts and tools for R32 or R410A. Using existing parts (for R22 or R407C) can cause the unit failure and serious accidents due to burst of the refrigerant circuit.
<ul style="list-style-type: none"> Do not put the drainage pipe directly into drainage channels where poisonous gases such as sulphide gas can occur. Poisonous gases will flow into the room through drainage pipe and seriously affect the user's health and safety. This can also cause the corrosion of the indoor unit and a resultant unit failure or refrigerant leak. Ensure that no air enters in the refrigerant circuit when the unit is installed and removed. If air enters in the refrigerant circuit, the pressure in the refrigerant circuit becomes too high, which can cause burst and personal injury. Do not process or splice the power cable, or share the socket with other power plugs. This may cause fire or electric shock due to deflecting contact, deflecting insulation and over-current etc.

<ul style="list-style-type: none"> Tighten the flare nut by torque wrench with specified method. If the flare nuts were tightened with excess torque, this may cause burst and refrigerant leakage after a long period. The electrical installation must be carried out by the qualified electrician in accordance with the norm for electrical work and national wiring regulation, and the system must be connected to the dedicated circuit. Power source with insufficient capacity and incorrect function done by improper work can cause electric shocks and fire. Failure to shut off the power before starting electrical work. Incorrect function of a plug can cause electric shocks, unit failure or fire. Be sure to use the cables conformed to safety standard and cable amperage for power distribution work. Unreformable cables can cause electric leak, anomalous heat production or fire. This appliance must be connected to main power source by means of a circuit breaker or switch (fuse-16-A) with a contact separation of at least 3 mm. Use the prescribed cables for electrical connection, tighten the cables securely in terminal block and relieve the cables correctly to prevent overloading the terminal blocks. Loose connections or cable mountings can cause anomalous heat production or fire. Arrange the wiring in the control box so that it cannot be pushed up further into the box. Install the service panel correctly. Incorrect installation may result in overheating and fire. Be sure to switch off the power source in the event of installation, inspection or servicing. If the power source is not shut off, there is a risk of electric shocks, unit failure or personal injury due to the unexpected start of fan. Be sure to wear protective goggles and gloves while at work. Earth leakage breaker must be installed. If the earth leakage breaker is not installed, it can cause electric shocks.
<ul style="list-style-type: none"> Do not bundle or wind or process the power cable. Do not deform the power cable by treating it. This may cause fire or heating. Do not vent R32 or R410A into atmosphere. R32 is a fluorinated greenhouse gas with a Global Warming Potential (GWP) = 675. R410A is a fluorinated greenhouse gas with a Global Warming Potential (GWP) = 2088. Do not run the unit with removed panels or protections. Touching rotating equipments, hot surfaces or high voltage parts can cause personal injury due to entrapment, burn or electric shocks. Do not perform any change of protective device itself or its setup condition. The forced operation by short-circuiting protective device of pressure switch and temperature control or the use of non specified component can cause fire or burst.

RFB012A008B

BEFORE INSTALLATION

○ Before installation check that the power source matches the air-conditioner.

Standard accessories (Installation kit)	Qty
Accessories for indoor unit	
① Installation board (Attached to the rear of the indoor unit)	1
② Wireless remote control	1
③ Remote control holder	1
④ Tapping screws (for installation board 04 X 25 mm)	9
⑤ Wood screws (for remote control switch holder 03.5 X 16 mm)	2
⑥ Battery [R03 (AAA, Micro) 1.5 V]	2
⑦ Air-cleaning filters	2
⑧ Filter holders (Attached to the front panel of indoor unit)	2
⑨ Pipe cover (200 mm)	1
⑩ Band	2

Locally procured parts	Qty
a Sealing plate	1
b Sleeve	1
c Inclination plate	1
d Putty	1
e Drain hose (extension hose)	1
f Piping cover (for insulation of connection piping)	1

Necessary tools for the installation work
1 Plus headed driver
2 Knife
3 Saw
4 Tape measure
5 Hammer
6 Spanner/wrench
7 Torque wrench (14.0 – 61.0 N·m (1.4 – 6.1 kgf·m))
8 Hole core drill (65 mm in diameter)
9 Wrench key (Hexagon) [4 mm]
10 Flaring tool set (Designed specifically for R32 or R410A)
11 Gas leak detector (Designed specifically for R32 or R410A)
12 Gauge for projection adjustment (Used when flare is made by using conventional flare tool)
13 Pipe bender

SELECTION OF INSTALLATION LOCATION

(Install at location that meets the following conditions, after getting approval from the customer)

Indoor unit

- When there is no obstruction to the air flow and where the cooled and heated air can be evenly distributed.
- A solid place where the unit or the wall will not vibrate.
- A place where there will be enough space for servicing. (Where space mentioned right can be secured)
- Where wiring and the piping work will be easy to conduct.
- The place where receiving part is not exposed to the direct rays of the sun or the strong rays of the street lighting.
- A place where it can be easily drained.
- A place separated at least 1 m away from the television or the radio. (To prevent interference to images and sounds.)
- A place separated at least 1 m away from the lighting equipment or electric equipment.
- Avoid installing this unit in a place where there is much dust.
- Places where there is no electric equipment or household under the installing unit.
- Install the indoor unit on flat wall.

Wireless remote control

- A place where the air-conditioner can be received the signal surely during operating the wireless remote control.
- Places where there is no affected by the TV and radio etc.
- Do not place where exposed to direct sunlight or near heat devices such as a stove.

INSTALLATION OF INDOOR UNIT

Open and detachment of the air inlet panel

- To open, pull the panel at both ends of upper part and release latches, and undo the strings. Then remove the panel.

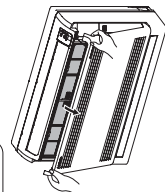

CAUTION
When removing the air inlet panel, be careful not to drop it on your feet.

How to remove the front panel

- ① Remove the air inlet panel.
- ② Remove the 5 set screws.
- ③ Remove the 3 latches in the upper section. If the latches are difficult to remove, push the latch portion out using a screw driver, for example.
- ④ Move the lower part of the panel forward and remove the 6 latches in the under section.

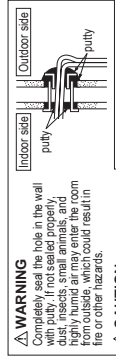
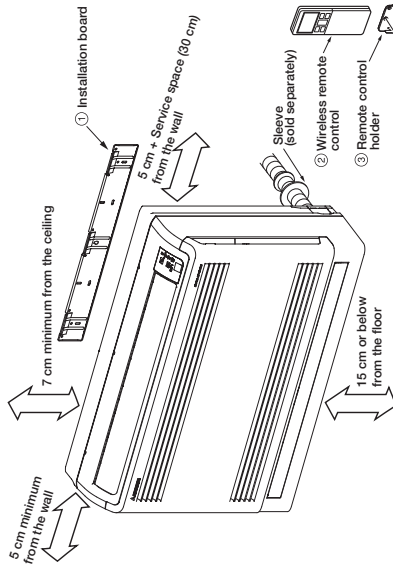
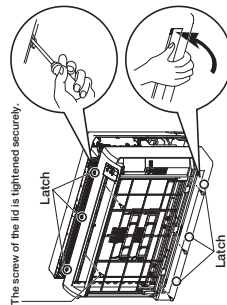

WARNING
Completely seal the hole in the wall with putty. If not sealed properly, dust, insects, small animals, and other things may enter from the outside, which could result in fire or other hazards.

CAUTION
Do not seal the hole in the wall with putty. If not sealed properly, furniture and other fixtures may be damaged by water leakage or condensation.

Installing the support of piping

In case of piping in the right rear direction

- Taping of the exterior
- Tape only the portion that goes through the wall.
- Always tape the wiring with the piping.

Sufficient care must be taken not to damage the panel when connecting pipes.

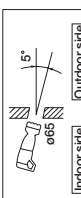
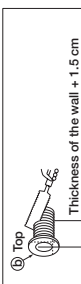
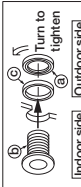
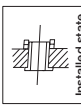

○ In case of rear piping draw out, cut off the lower and the right side portions of the sleeve collar.

Indoor unit piping direction

Piping is possible in the rear, left rear, left downward, right or downward direction.

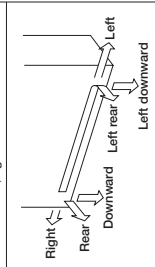

For Right or Left rear piping

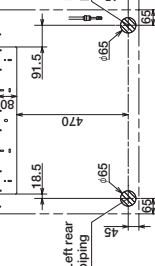

For Right or Left piping

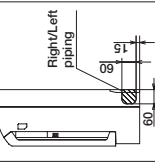

For Right or Left bottom piping

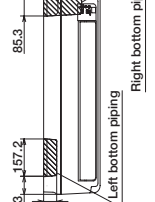

CAUTION

Be careful not to stress the connecting refrigerant pipes. (Do not pull with a force of larger than 5 kgf.) If improperly installed, it may cause abnormal noise and vibration.

Drainage

- Arrange the drain hose in a downward angle.
- Avoid the following drain piping.

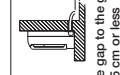
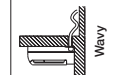
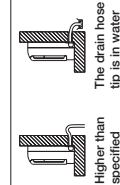

CAUTION Go through all installation steps and check if the drainage is all right. Otherwise water leak may occur.

- Pour water to the drain pan located under the heat exchanger, and ensure that the water is discharged outdoor.
- When the extended drain hose is indoor, securely/insulate it with a heat insulator available in the market.

Fixing of indoor unit

△ CAUTION • During the installation, do not lean on the control box or the display, as they may be damaged.
• Install the indoor unit on flat wall. If improperly installed, it may cause abnormal noise and vibration. (Distortion on the wall shall be no larger than 3 mm.)

Floor installation

Secure using upper 2 screws for floor installations.
If possible, also attach two lower screws.

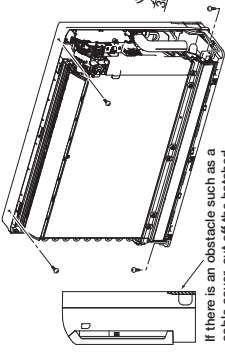

Wall installation

At first secure the installation board using 5 screws and the indoor unit using 2 screws.

Installation of Installation board

Look for the inside wall structures (intermediate support or pillar) and finally install the unit after level surface has been checked.)



○ Adjustment of the installation board in the horizontal direction is to be conducted with five screws in a temporary tightened state.
○ Adjust so the board will be level by turning the board with the standard hole as the center.

Fixing on concrete wall

Use of nut anchor

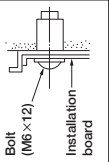

④ Tapping screw

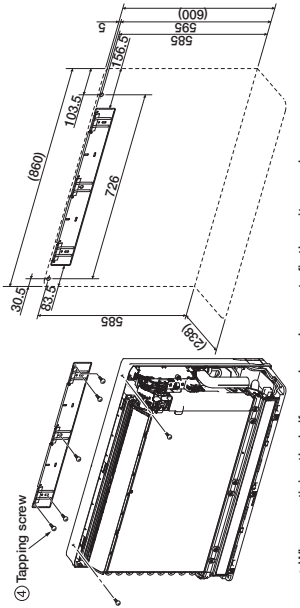

○ When practicing the half-console, make sure to fix the unit securely. Otherwise, it could fall.

CONNECTION OF REFRIGERANT PIPINGS

Preparation Keep the openings of the pipes covered with tapes etc. to prevent dust, sand, etc. from entering them.

Indoor (Do not turn)



○ Remove the flared nuts. (on both liquid and gas sides)
○ Install the removed flared nuts to the pipes to be connected, then flared the pipes.



Dimension A (mm)
Liquid side $\phi 6.35 \pm 0.1$
Gas side $\phi 9.52 \pm 13.2$
 $\phi 12.7 \pm 16.6$

△ CAUTION Do not apply refrigerating machine oil to the flared surface.

Flaring work

Copper pipe diameter	Measurement B (mm)	
	Clutch type flare tool for R32 or R410A	Conventional (R22) flare tool Clutch type
$\phi 6.35$	0.0 - 0.5	1.0 - 1.5
$\phi 9.52$	0.0 - 0.5	1.0 - 1.5
$\phi 12.7$	0.0 - 0.5	1.0 - 1.5

Use a flare tool designed for R32, R410A or a conventional flare tool. Note that measurement B (protrusion from the flaring block) will vary depending on the type of a flare tool in use. If a conventional flare tool is used, use a copper pipe gauge or a similar instrument to check protrusion so that you can keep measurement B to a correct value.

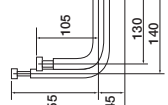

Pass the refrigerant pipe through the piping hole to indoor side.
Arrange the pipes according to the direction of piping.

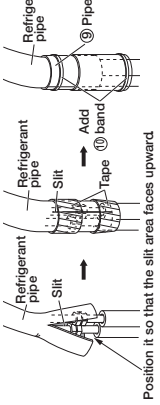

Finishing work and fixing

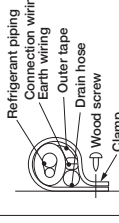

Refrigerant piping
Connection wiring
Earth wiring
Outer tape
Drain hose
Wood screw
Clamp

Cover the exterior portion with outer tape and shape the piping so it will match the contours of the route that the piping to take. Also fix the wiring and pipings to the wall with clamps.

△ CAUTION Do not apply excess torque to the flared nuts. Otherwise, the flared nuts may check depending.

○ Connect the pipes on both liquid and gas sides.
○ Tighten the nuts to the following torque:
Liquid side ($\phi 6.35$) : 14.0 - 18.0 N·m (1.4 - 1.8 kgf·m)
Gas side ($\phi 9.52$) : 34.0 - 42.0 N·m (3.4 - 4.2 kgf·m)
($\phi 12.7$) : 49.0 - 61.0 N·m (4.9 - 6.1 kgf·m)

△ CAUTION Be careful not to stress the connecting refrigerant pipes. (Do not pull with a force of larger than 5 kgf.)

Connection

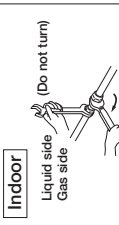

Insulation of the connection portion

Cover the coupling with insulator and then cover it with tapes.
Use an attached pipe cover for heat insulation.

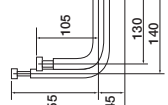

△ CAUTION If heat insulation is insufficient, water leakage may occur. In addition, the room temperature sensor may give a false alert due to heat radiation from the pipes.

• Cover the indoor unit's flare-connected joints, after they are checked for a gas leak, with an indoor unit heat insulating material and then wrap them with a tape with an attached pipe cover placed over the heat insulating material's slit area.

ELECTRICAL WIRING WORK

Preparation of indoor unit

Mounting of connecting wires

- Remove the fixing screw of clamp.
- Connect the connecting wire securely to the terminal block. If the wire is not affixed completely, contact will be poor, and it is dangerous as the terminal block may heat up and catch fire.
- Take care not to confuse the terminal numbers for indoor and outdoor connections.
- Fix the connecting wire by wiring clamp.
- Pass the connecting wire through the wiring holder.

△ CAUTION
• During installation, do not lean on the control box or the display, as they may be damaged.
• Pass the connecting wire securely through the wiring holder. If it passes on the sensor, it may not detect suction temperature and/or humidity.

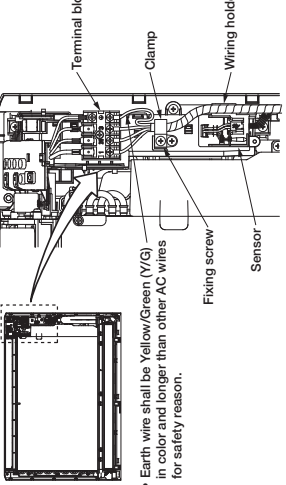

○ In case of faulty wiring connection, the indoor unit stops, and then the run lamp turns on and the timer lamp blinks.

Use cables for interconnection wiring to avoid loosening of the wires.
CENELEC code for cables Required field cables.

Code	Conductor type
H	Heat resistant cable type
OS	300/500 volt type
N	Nett-leak-proof synth. rubber wire insulation
R	Polychloroprene rubber conductors insulation
G	Stranded conductor
4	4 or 5 Number of conductors
1.5	Outer diameter of the cable is the earth conductor (yellow/green)
1.5	Section of copper wire (mm ²)

How to fit the front panel

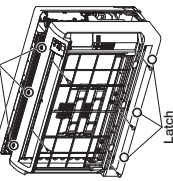

- Offitting**
1. Do remove the air filter.
 2. Cover the body with the front panel.
 3. Fit the 6 latches in the lower section, then 3 latches in the upper section.
 4. Tighten the 5 set screws.
 5. Fit the air filter.
 6. Fit the air inlet panel.

Close and attachment of the air inlet panel

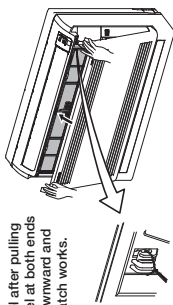

1. To close, attach the panel after pulling the strings, hold the panel at both ends or upper part to lower downward and push it slightly until the latch works.

Installing the air-cleaning filters

1. Open the air inlet panel and remove the air filters.
2. Install the air-cleaning filter in the filter holders, and then install the filter holders in the air-conditioner.
 - Each air-cleaning filter can be installed in the upper or lower filter holder.
3. Install the air filters and close the inlet panel.

CAUTION
When installing an air-cleaning filter in the indoor unit, be careful not to injure your hand with the heat exchanger.

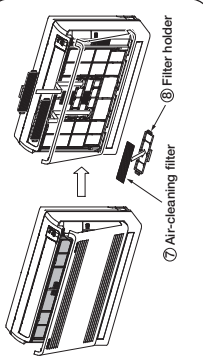

INSTALLING TWO AIR-CONDITIONERS IN THE SAME ROOM

When two air-conditioners are installed in the same room, use this setting when the two air-conditioners are not operated with one remote control. Set the remote control and indoor unit.

Setting the remote control

1. Pull out the cover and take out batteries.
2. Disconnect the switching line next to the battery with wire cutters.
3. Insert batteries. Close the cover.

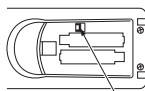

Setting an indoor unit

1. Turn off the power source, and turn it on after 1 minute.
2. Point the remote control that was set according to the procedure described on the left side at the indoor unit and send a signal by pressing the ACL switch on the remote control. Since the signal is sent in about 6 seconds after the ACL switch is pressed, point the remote control at the indoor unit for some time.

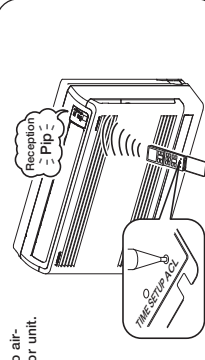

3. Check that the reception buzzer sound "Pip" is emitted from the indoor unit. At completion of the setting, the indoor unit emits a buzzer sound "Pip". (If no reception tone is emitted, start the setting from the beginning again.)

Concealed installation

- Install the indoor unit according to the following instructions.
1. Secure the upper, right, and left spaces according to the right figure.
 2. Do not let the horizontal bar obstruct wind from blowing out upward/downward or reception from the remote control.
 3. The lattice size should be 70% or greater of the open rate.
 4. Cut the jumper cable (JP17.3) on the indoor circuit board to control the blow-out angle.

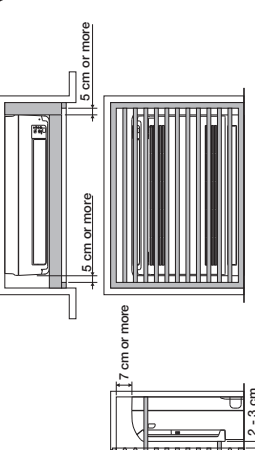
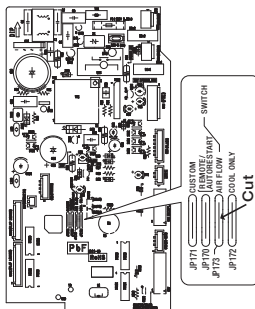

CONCERNING TERMINAL CONNECTION FOR AN INTERFACE

1. Remove the front panel and lid of control.
2. There is a terminal (respectively marked with CNS) for the indoor control board. In connecting an interface, connect to the respective terminal securely with the connection harness supplied with an option "Interface" connection kit SC-BIKN2-E" and fasten the connection harness onto the indoor control box, with the clamp supplied with the kit. For more details, please refer to the user's manual of your "Interface" connection kit SC-BIKN2-E".

INSTALLATION OF WIRELESS REMOTE CONTROL

Mounting method of battery

1. Uncover the wireless remote control, and mount the batteries [R03 (AAA, Micro), x 2 pieces] in the body regularly. (Fit the poles with the indication marks, ⊕ & ⊖ without fail)

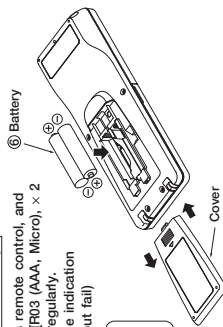

CAUTION
Do not use new and old batteries together.

Fixing to pillar or wall

1. Conventionally, operate the wireless remote control by holding in your hand.
2. Avoid installing it on a clay wall etc.

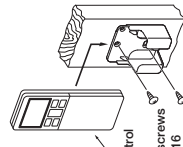

HOW TO RELOCATE OR DISPOSE OF THE UNIT

- In order to protect the environment, be sure to pump down (recovery of refrigerant).
- Pump down is the method of recovering refrigerant from the indoor unit to the outdoor unit when the pipes are removed from the unit.

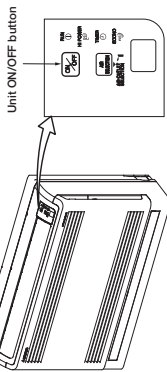

- <How to pump down>**
1. Connect charge hose to service port of outdoor unit.
 2. Liquid side: Close the liquid valve with hexagon wrench key. Gas side: Fully open the gas valve. Carry out cooling operation. (If indoor temperature is low, operate forced cooling operation.)
 3. After low pressure gauge become 0.01 MPa, stop cooling operation and close the gas valve.

INSTALLATION TEST CHECK POINTS

- After installation**
- The power source voltage is correct as the rating.
 - No gas leaks from the joints of the service valve.
 - Power cables and crossover wires are securely fixed to the terminal board.
 - The screw of the lid is tightened securely.

- Test run**
- Air-conditioning operation is normal.
 - No abnormal noise.
 - Water drains smoothly.
 - Protective functions are not working.

Check the following points again after completion of the installation, and before turning on the power. Conduct a test run again and ensure that the unit operates properly. At the same time, explain to the customer how to use the unit and how to take care of the unit following the user's manual.

- The remote control is normal.
- Operation of the unit has been explained to the customer. (Three-minutes restart preventive timer) When the air-conditioner is restarted or when changing the operation, the unit will not start operating for approximately 3 minutes. This is to protect the unit and it is not a malfunction.

(2) Installation of outdoor unit

RWC012A068G

Models SRC25ZS-W2, 35ZS-W2

Model SRC20,25,35,50ZS-W
SRC20,25,35ZS-WA
R32 REFRIGERANT USED

• This installation manual deals with an outdoor unit installation only. For an indoor unit installation, refer to page 30.

SAFETY PRECAUTIONS

- Before installation, read the "SAFETY PRECAUTIONS" carefully and strictly follow it during the installation work in order to protect yourself.
 - The precautionary items mentioned below are distinguished into two levels, **WARNING** and **CAUTION**.
 - WARNING** Indicates a potentially hazardous situation which, if not avoided, can result in serious consequences such as death or severe injury.
 - CAUTION** Indicates a potentially hazardous situation which, if not avoided, can result in personal injury or property damage.
- Both mention the important items to protect your health and safety. Therefore, strictly follow them by any means.



WARNING

- **Be sure to use only for residential purpose.**
If this unit is installed in interior environment such as machine shop, vehicle (like ship), warehouse, etc., it can malfunction.
- **Installation must be carried out by the qualified installer completely in accordance with the installation manual.**
Installation by non qualified person or incorrect installation can cause serious troubles such as water leak, electric shock, fire and personal injury.
- **Be sure to wear protective goggles and gloves while performing installation work.**
Improper safety measures can result in personal injury.
- **Use the original accessories and the specified components for the installation.**
Using parts other than those prescribed may cause water leak, electric shock, fire and personal injury.
- **Do not install the unit near the location where leakage of flammable gases can occur.**
If leaked gases accumulate around the unit, it can cause fire resulting in property damage and personal injury.
- **When installing the unit in small rooms, make sure that refrigerant density does not exceed the limit (Reference: ISO5149) in the event of leakage.**
If refrigerant density exceeds the limit, consult the dealer and install the ventilation system. Otherwise lack of oxygen can occur resulting in serious accident.
- **Install the unit in a location where unit will remain stable, horizontal and free of any vibration transmission.**
Unsuitable installation location can cause the unit to fall resulting in material damage and personal injury.
- **Do not run the unit with removed panels or protections.**
Touching rotating equipments, hot surfaces or high voltage parts can cause personal injury due to entrapment, burn or electric shock.
- **This unit is designed specifically for R32.**
Using any other refrigerant can cause unit failure and personal injury.
- **Do not vent R32 into atmosphere.**
R32 is a fluorinated greenhouse gas with a Global Warming Potential (GWP) = 675.
- **Make sure that no air enters the refrigerant circuit when the unit is installed and removed.**
If air enters the refrigerant circuit, the pressure in the refrigerant circuit will become too high, which can cause burst and personal injury.
- **Be sure to use the prescribed pipes, flare nuts and tools for R32 or R410A.**
Using existing parts (for R22 or R407C) can cause refrigerant circuit burst resulting in unit failure and personal injury.
- **Be sure to connect both liquid and gas connecting pipes properly before operating the compressor. Do not open the liquid and gas service valves before completing piping work, and evacuation.**
If the compressor is operated when connecting pipes are not connected and service valves are open, air can be sucked into the refrigerant circuit which can cause anomalous high pressure resulting in burst or personal injury.
- **Be sure to tighten the flare nuts to specified torque using the torque wrench.**
Tightening flare nuts with excess torque can cause burst and refrigerant leakage after a long period.
- **During pump down work, be sure to stop the compressor before closing service valves and removing connecting pipes.**
If the connecting pipes are removed when the compressor is in operation and service valves are open, air can be sucked into the refrigerant circuit which can cause anomalous high pressure resulting in burst or personal injury.
- **In the event of refrigerant leakage during installation, be sure to ventilate the working area properly.**
If the refrigerant comes into contact with naked flames, poisonous gases will be produced.
- **Electrical work must be carried out by the qualified electrician, strictly in accordance with national or regional electricity regulations.**
Incorrect installation can cause electric shock, fire or personal injury.
- **Make sure that earth leakage breaker and circuit breaker of appropriate capacities are installed.**
Circuit breaker should be able to disconnect all poles under over current. Absence of appropriate breakers can cause electric shock, personal injury or property damage.
- **Be sure to switch off the power source in the event of installation, maintenance or service.**
If the power source is not switched off, there is a risk of electric shock, unit failure or personal injury.
- **Be sure to tighten the cables securely in terminal block and relieve the cables properly to prevent overloading the terminal blocks.**
Loose connections or cable mountings can cause anomalous heat production or fire.
- **Do not process, splice or modify the power cable, or share the socket with other power plugs.**
Improper power cable or power plug can cause fire or electric shock due to poor connection, insufficient insulation or over-current.
- **Do not perform any change in protective device or its setup condition yourself.**
Changing protective device specifications can cause electric shock, fire or burst.
- **Be sure to clamp the cables properly so that they do not touch any internal component of the unit.**
If cables touch any internal component, it can cause overheating and fire.
- **Be sure to install service cover properly.**
Improper installation can cause electric shock or fire due to intrusion of dust or water.
- **Be sure to use the prescribed power and connecting cables for electrical work.**
Using improper cables can cause electric leak or fire.
- **This appliance must be connected to main power source by means of a circuit breaker or switch with a contact separation of at least 3 mm.**
Improper electrical work can cause unit failure or personal injury.
- **Be sure to connect the power source cable with power source properly.**
Improper connection can cause intrusion of dust or water resulting in electric shock or fire.

CAUTION

- **Take care when carrying the unit by hand.**
If the unit weight is more than 20 kg, it must be carried by two or more persons. Do not carry the unit by the plastic straps. Always use the carry handle.
- **Do not install the outdoor unit in a location where insects and small animals can inhabit.**
Insects and small animals can enter the electrical parts and cause damage resulting in fire or personal injury. Instruct the user to keep the surroundings clean.
- **If the outdoor unit is installed at height, make sure that there is enough space for installation, maintenance and service.**
Insufficient space can result in personal injury due to falling from the height.
- **Do not install the unit near the location where neighbours are bothered by noise or air generating from the unit.**
It can affect surrounding environment and cause a claim.
- **Do not install in the locations where unit is directly exposed to corrosive gases (like sulphide gas, chloride gas), sea breeze or salty atmosphere.**
It can cause corrosion of heat exchanger and damage to plastic parts.
- **Do not install the unit close to the equipments that generate electromagnetic waves and/or high-harmonic waves.**
Equipment such as inverters, standby generators, medical high frequency equipments and telecommunication equipments can affect the system, and cause malfunctions and breakdowns. The system can also affect medical equipment and telecommunication equipment, and obstruct its function or cause jamming.
- **Do not install the unit in the locations where:**
 - There are heat sources nearby.
 - Unit is directly exposed to rain or sunlight.
 - There is any obstacle which can prevent smooth air circulation from inlet and outlet side of the unit.
 - Unit is directly exposed to oil mist and steam such as kitchen.
 - Chemical substances like ammonia (organic fertilizer), calcium chloride (snow melting agent) and acid (sulfurous acid etc.), which can harm the unit, will generate or accumulate.
 - Drain water can not be discharged properly.
 - TV set or radio receiver is placed within 1 m.
 - Height above sea level is more than 1000 m.
 It can cause performance degradation, corrosion and damage of components, unit malfunction and fire.
- **Dispose of all packing materials properly.**
Packing materials contain nails and wood which can cause personal injury. Keep the polybag away from children to avoid the risk of suffocation.
- **Do not put anything on the outdoor unit.**
Object may fall causing property damage or personal injury.
- **Do not touch the aluminum fin of the outdoor unit.**
Aluminium fin temperature is high during heating operation. Touching fin can cause burn.
- **Do not touch any refrigerant pipe with your hands when the system is in operation.**
During operation the refrigerant pipes become extremely hot or extremely cold depending on the operating condition. Touching pipes can cause personal injury like burn (hot/cold).
- **Install isolator or disconnect switch on the power source wiring in accordance with the local codes and regulations.**
The isolator should be locked in OFF state in accordance with EN60204-1.

1. ACCESSORIES AND TOOLS

Standard accessories (Supplied with outdoor unit)		Qty	Locally procured parts		Tools for installation work		
(1)	Drain grommet 	1	(a)	Anchor bolt(M10-M12) × 4 pcs.	Plus headed driver	Spanner wrench	Vacuum pump*
(2)	Drain elbow 	1	(b)	Putty	Knife	Torque wrench [14.0-62.0 N•m(1.4-6.2 kg•m)]	Gauge manifold *
			(c)	Electrical tape	Saw	Wrench key (Hexagon) [4 mm]	Charge hose *
			(d)	Connecting pipe	Tape measure	Flaring tool set *	Vacuum pump adapter* (Anti-reverse flow type)
			(e)	Connecting cable	Pipe cutter	Flare adjustment gauge	Gas leak detector *
			(f)	Power cable			
			(g)	Clamp and screw (for finishing work)			

*Not included for SRC20, 25, or 35ZS-WA.

*Designed specifically for R32 or R410A

2. OUTDOOR UNIT INSTALLATION

Note as a unit designed for R32

- Do not use any refrigerant other than R32. R32 will rise to pressure about 1.6 times higher than that of a conventional refrigerant. A cylinder containing R32 has a light blue indication mark on the top.
- Do not use a charge cylinder. The use of a charge cylinder will cause the refrigerant composition to change, which results in performance degradation.
- In charging refrigerant, always take it out from a cylinder in the liquid phase.
- All indoor units must be models designed exclusively for R32. Check connectable indoor unit models in a catalog, etc. (A wrong indoor unit, if connected into the system, will impair proper system operation)

1. Haulage

- Always carry or move the unit with two or more persons.
 - The right hand side of the unit as viewed from the front (outlet side) is heavier.
- A person carrying the right hand side must take care of this fact. A person carrying the left hand side must hold the handle provided on the front panel of the unit with his right hand and the corner column section of the unit with his left hand.

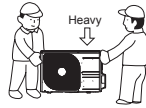

CAUTION

When a unit is hauled, take care of its gravity center position which is shifted towards right hand side. If the unit is not hauled properly, it can go off balance and fall resulting in serious injury.

2. Selecting the installation location

Select the suitable installation location where:

- Unit will be stable, horizontal and free of any vibration transmission.
- There is no obstacle which can prevent smooth air circulation from inlet and outlet side of the unit.
- There is enough space for service and maintenance of unit.
- Neighbours are not bothered by noise or air generating from the unit.
- Outlet air of the unit does not blow directly to animals or plants.
- Drain water can be discharged properly.
- There is no risk of flammable gas leakage.
- There are no other heat sources nearby.
- Unit is not directly exposed to rain or sunlight.
- Unit is not directly exposed to oil mist and steam.
- Chemical substances like ammonia (organic fertilizer), calcium chloride (snow melting agent) and acid (sulfurous acid etc.), which can harm the unit, will not generate or accumulate.
- Unit is not directly exposed to corrosive gases (like sulphide gas, chloride gas), sea breeze or salty atmosphere.
- No TV set or radio receiver is placed within 1 m.
- Unit is not affected by electromagnetic waves and/or high-harmonic waves generated by other equipments.
- Strong wind does not blow against the unit outlet.
- Heavy snowfalls do not occur (If installed, provide proper protection to avoid snow accumulation).

NOTE

If the unit is installed in the area where there is a possibility of strong wind or snow accumulation, the following measures are required.

(1) Location of strong wind

- Place the unit with its outlet side facing the wall.
- Place the unit such that the direction of air from the outlet gets perpendicular to the wind direction.



(2) Location of snow accumulation

- Install the unit on the base so that the bottom is higher than snow cover surface.
- Install the unit under eaves or provide the roof on site.

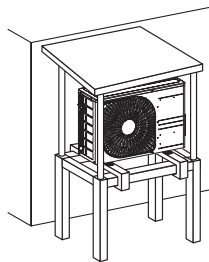

3. Installation space

- There must be 1 m or larger space between the unit and the wall in at least 1 of the 4 sides. Walls surrounding the unit from 4 sides is not acceptable. The wall height on the outlet side should be 1200 mm or less. Refer to the following figure and table for details.

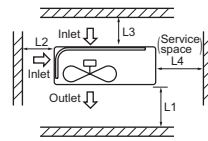

	Installation space (mm)
L1	280 or more
L2	100 or more
L3	80 or more
L4	250 or more

NOTE

When more than one unit are installed side by side, provide a 250 mm or wider interval between them as a service space.

CAUTION

When more than one unit are installed in parallel directions, provide sufficient inlet space so that short-circuiting may not occur.

4. Drain piping work (If necessary)

Carry out drain piping work by using a drain elbow and a drain grommet supplied separately as accessories if condensed water needs to be drained out.

- Install drain elbow and drain grommet.
- Seal around the drain elbow and drain grommet with putty or adequate caulking material.

<SRC20/25/35/50ZS-W>

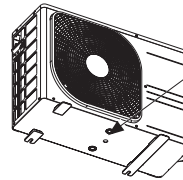

Do not put a grommet on this hole. This is a supplementary drain hole to discharge drain water, when a large amount of it is gathered.

CAUTION

Do not use drain elbow and drain grommet if there is a possibility to have several consecutive days of sub zero temperature. (There is a risk of drain water freezing inside and blocking the drain.)

<SRC20/25/35ZS-WA>

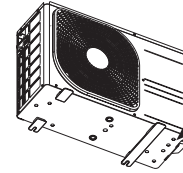

Do not block the drain holes when installing the outdoor unit.

5. Installation

- Install the unit on a flat level base.
- While installing the unit, keep space and fix the unit's legs with 4 anchor bolts as shown in the figure below. The protrusion of an anchor bolt from the foundation surface must be kept within 15 mm.

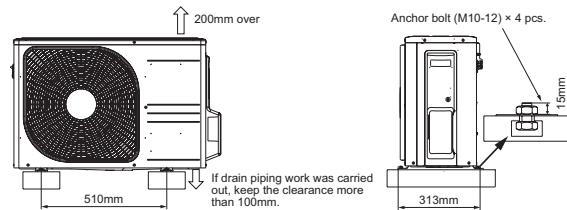

CAUTION

- Install the unit properly so that it does not fall over during earthquake, strong wind, etc.
- Make sure that unit is installed on a flat level base. Installing unit on uneven base may result in unit malfunction.

3. PREPARATION FOR WORK

1. Removing service cover

Remove the screw. Slide service cover downwards and remove it.

<SRC20/25/35>

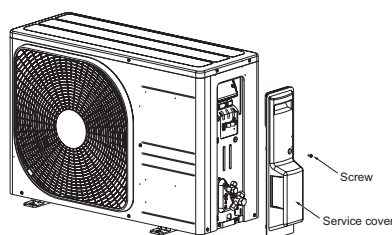

<SRC50>

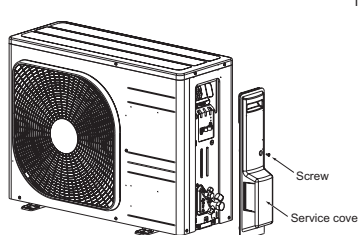

2. Removing terminal cover

Remove the screw and take out terminal cover.

(For SRC50, terminal cover is attached to service cover. Therefore, there is no need to remove terminal cover separately.)

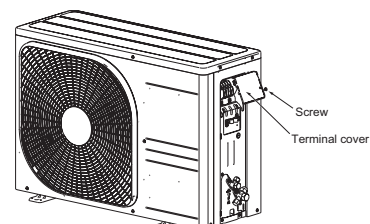

4. CONNECTING PIPING WORK

1. Restrictions on unit installation

Abide by the following restrictions on unit installation. Improper installation can cause compressor failure or performance degradation.

	Dimensional restrictions	
	Model SRC20/25/35	Model SRC50
Connecting pipe length(L)	20 m or less	25 m or less
Elevation difference between indoor and outdoor units(H)*	10 m or less	15 m or less

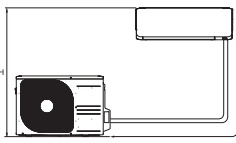

* Outdoor unit installation position can be higher as well as lower than the indoor unit installation position.

2. Preparation of connecting pipe

2.1 Selecting connecting pipe

Select connecting pipe according to the following table.

	Model SRC20/25/35	Model SRC50
Gas pipe	φ 9.52	φ 12.7
Liquid pipe	φ 6.35	φ 6.35

- Pipe wall thickness must be greater than or equal to 0.8 mm.
- Pipe material must be O-type (Phosphorus deoxidized seamless copper pipe ICS 23.040.15, ICS 77.150.30).

NOTE

If it is required to reuse the existing connecting pipe system, refer to 5. UTILIZATION OF EXISTING PIPE.

2.2 Cutting connecting pipe

- (1) Cut the connecting pipe to the required length with pipe cutter.
- (2) Hold the pipe downward and remove the burrs. Make sure that no foreign material enters the pipe.
- (3) Cover the connecting pipe ends with the tape.

3. Piping work

Check that both liquid and gas service valves are fully closed. Carry out the piping work with service valves fully closed.

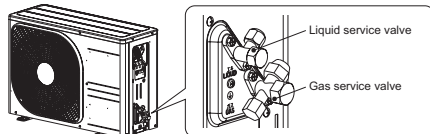

3.1 Flaring pipe

- (1) Take out flare nuts from the service valves of outdoor unit and engage them onto connecting pipes.
- (2) Flare the pipes according to table and figure shown below. Flare dimensions for R32 are different from those for conventional refrigerant. Although it is recommended to use the flaring tools designed specifically for R32 or R410A, conventional flaring tools can also be used by adjusting the dimension B with a flare adjustment gauge.

Copper pipe outer diameter	A	B (Rigid (clutch) type)	
		R32 or R410A	Conventional
φ 6.35	9.1	0-0.5	1.0-1.5
φ 9.52	13.2		
φ 12.7	16.6		

3.2 Connecting pipes

- (1) Connect pipes on both liquid and gas sides.
- (2) Tighten nuts to specified torque shown in the table below.

Service valve size (mm)	Tightening torque (N·m)
φ 6.35 (1/4")	14-18
φ 9.52 (3/8")	34-42
φ 12.7 (1/2")	49-61

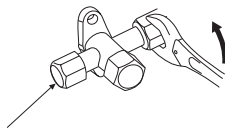

Do not hold the valve cap area with a spanner

CAUTION

- Do not apply refrigerating machine oil to the flared surface. It can cause refrigerant leakage.
- Do not apply excess torque to the flared nuts. The flared nuts may crack resulting in refrigerant leakage.

4. Evacuation

- (1) Connect vacuum pump to gauge manifold. Connect charge hose of gauge manifold to service port of outdoor unit.
- (2) Run the vacuum pump for at least one hour after the vacuum gauge shows -0.1 MPa (-76 cm Hg).
- (3) Confirm that the vacuum gauge indicator does not rise even if the system is left for 15 minutes or more. Vacuum gauge indicator will rise if the system has moisture left inside or has a leakage point. Check the system for the leakage point. If leakage point is found, repair it and return to (1) again.
- (4) Close the Handle Lo and stop the vacuum pump. Keep this state for a few minutes to make sure that the compound pressure gauge pointer does not swing back.
- (5) Remove valve caps from liquid service valve and gas service valve.
- (6) Turn the liquid service valve's rod 90 degree counterclockwise with a hexagonal wrench key to open valve. Close it after 5 seconds, and check for gas leakage. Using soapy water, check for gas leakage from indoor unit's flare and outdoor unit's flare and valve rods. Wipe off all the water after completing the check.
- (7) Disconnect charging hose from gas service valve's service port and fully open liquid and gas service valves. (Do not attempt to turn valve rod beyond its stop.)
- (8) Tighten service valve caps and service port cap to the specified torque shown in the table below.

Service valve size (mm)	Service valve cap tightening torque (N·m)	Service port cap tightening torque (N·m)
φ 6.35 (1/4")	20-30	10-12
φ 9.52 (3/8")		
φ 12.7 (1/2")	25-35	

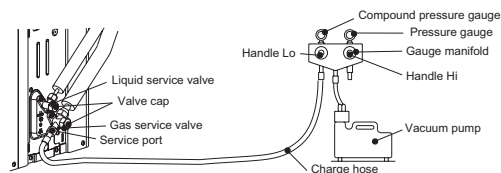

CAUTION

To prevent vacuum pump oil from entering into the refrigerant system, use a counterflow prevention adapter.

5. Additional refrigerant charge

Additional refrigerant charge is required only when connecting pipe length exceeds A m.

5.1 Calculating additional refrigerant charge

Additional refrigerant charge can be calculated using the formula given below.

$$\text{Additional refrigerant charge (g)} = \{ \text{Connecting pipe length (m)} - \text{Factory charged length A (m)} \} \times 20 \text{ (g/m)}$$

	Model SRK, SRR SRF35, FDTC	Model SRF25
A : Factory charged length (m)	15	10

NOTE

- If additional refrigerant charge calculation result is negative, there is no need to remove the refrigerant.
- If refrigerant recharge is required for the unit with connecting pipe length A m or shorter, charge the factory charged amount as shown in the table below.
- The maximum refrigerant charge amount is designed as shown in the table below.

	Model SRC20/25	Model SRC35	Model SRC50
The factory refrigerant charge amount(kg)	0.62	0.78	1.05
The maximum refrigerant charge amount(kg)	0.72 (SRF25: 0.82)	0.88	1.25

5.2 Charging refrigerant

- (1) Charge the R32 refrigerant in liquid phase from service port with both liquid and gas service valves shut. Since R32 refrigerant must be charged in the liquid phase, make sure that refrigerant is discharged from the cylinder in the liquid phase all the time.
- (2) When it is difficult to charge a required refrigerant amount, fully open both liquid and gas service valves and charge refrigerant, while running the unit in the cooling mode. When refrigerant is charged with the unit being run, complete the charge operation within 30 minutes.
- (3) Write the additional refrigerant charge calculated from the connecting pipe length on the label attached on the service cover.

CAUTION

- Running the unit with an insufficient quantity of refrigerant for a long time can cause unit malfunction.
- Do not charge more than the maximum refrigerant amount. It can cause unit malfunction.

5. UTILIZATION OF EXISTING PIPE

(1) Check whether an existing pipe system is reusable or not by using the following flow chart.

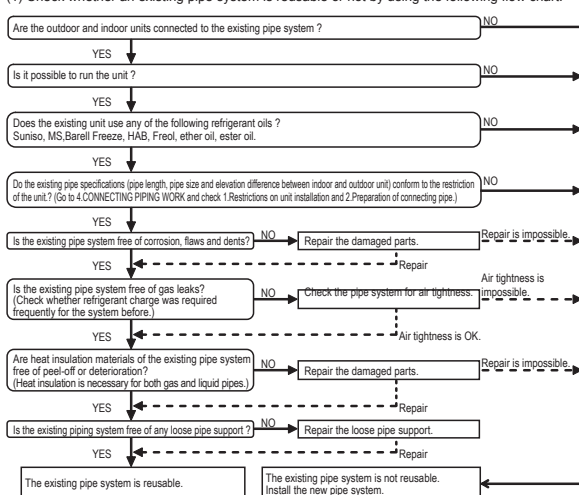

NOTE

- Consult with our distributor in the area, if you need to recover refrigerant and charge it again.
- (2) Clean the existing pipe system according to the procedure given below.
 - (a) Carry out forced cooling operation of existing unit for 30 minutes. For 'Forced cooling operation' refer to the indoor unit installation manual.
 - (b) Stop the indoor fan and carry out forced cooling operation for 3 minutes (Liquid return).
 - (c) Close the liquid service valve of the outdoor unit and carry out pump down operation (Refer to 6. PUMP DOWN).
 - (d) Blow with nitrogen gas. If discolored refrigeration oil or any foreign matter is discharged by the blow, wash the pipe system or install a new pipe system.
- (3) Remove the flare nuts from the existing pipe system. Go back to 4. CONNECTING PIPING WORK and proceed to step 2.2 Cutting connecting pipe.

CAUTION

- Do not use the old flare nuts (of existing unit). Make sure that the flare nuts supplied with the (new) outdoor unit are used.
- If the flared / compression connection to the indoor unit is located inside the house / room then this pipework can't be reused.

* If the existing piping is specified as liquid pipe φ9.52 or gas pipe φ12.7, refer to the following. (SRC50 only)

<Table of pipe size restrictions>

Additional charge amount per meter of pipe		0.054 kg/m
Pipe size	Liquid pipe	φ9.52
	Gas pipe	φ12.7
Maximum one-way pipe length		10
Length covered without additional charge		5

Additional charge amount (kg) = (Main pipe length (m) - Length covered without additional charge shown in the table (m)) X Additional charge amount per meter of pipe shown in the table (kg/m)

6. PUMP DOWN

- (1) Connect charge hose of gauge manifold to service port of outdoor unit.
- (2) Close the liquid service valve with hexagonal wrench key.
- (3) Fully open the gas service valve with hexagonal wrench key.
- (4) Carry out forced cooling operation (For forced cooling operation procedure, refer to indoor unit installation manual).
- (5) When the low pressure gauge becomes 0.01 MPa, close the gas service valve and stop forced cooling operation.

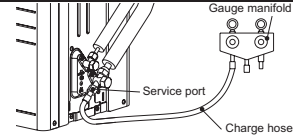

7. ELECTRICAL WIRING WORK

⚠ WARNING

- Make sure that all the electrical work is carried out in accordance with the national or regional electrical standards.
- Make sure that the earth leakage breaker and circuit breaker of appropriate capacities are installed (Refer to the table given below).
- Do not turn on the power until the electrical work is completed.
- Do not use a condensative capacitor for power factor improvement under any circumstances. (It does not improve power factor. Moreover, it can cause an abnormal overheat accident).

Breaker specifications

Model	Phase	Earth leakage breaker	Circuit breaker
SRC20/25/35	Single phase	Leakage current: 30 mA, 0.1sec or less	Over current: 16 A
SRC50			Over current: 20 A

Main fuse specification

Model	Specification	Parts No.	Code on LABEL, WIRING
SRC20/25/35	250 V 15 A	SSA564A136	F7
SRC50	250 V 20 A	SSA564A136A	F4

1. Preparing cable

- (1) Selecting cable
 - (a) Power source cable
 - 3cores* 2.5mm² or more, conformed with 60245 IEC57
 - When selecting the power source cable length, make sure that voltage drop is less than 2%. If the wire length gets longer, increase the wire diameter.
 - (b) Connecting cable
 - 4cores* 1.5mm², conformed with 60245 IEC57
 - * 1 Earth wire is included (Yellow/Green).
- (2) Arrange each wire length as shown below.
 - Make sure that each wire is stripped 10mm from the end.

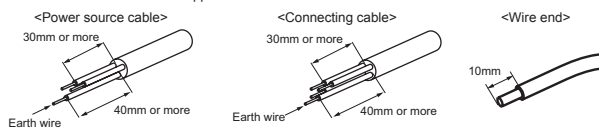

- (3) Attach round crimp-type terminal to each wire as shown in the below.
 - Select the size of round crimp-type terminal after considering the specifications of terminal block and wire diameter.

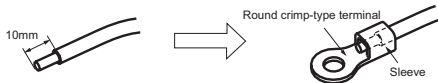

⚠ CAUTION

Power source cable and connecting cable must conform to the specifications mentioned in the manual. Using cables with wrong specifications may result in unit malfunction.

2. Connecting cable

- (1) Remove the service cover.
- (2) Connect the cables according to the instructions and figures given below.
 - (a) Connect the earth wire of power source cable.
 - An earth wire must be connected before connecting the other wires of power source cable. Keep the earth wire longer than the remaining two wires of power source cable.
 - (b) Connect the remaining two wires (N and L) of power source cable.
 - (c) Connect the wires of connecting cable. Make sure that for each wire, outdoor and indoor side terminal numbers match.
- (3) Fasten the cables properly with cable clamps so that no external force may work on terminal connections.

Moreover, make sure that cables do not touch the piping, etc. When cables are connected, make sure that all electrical components within the electrical component box are free of loose connector coupling or terminal connection.

<Circuit diagram>

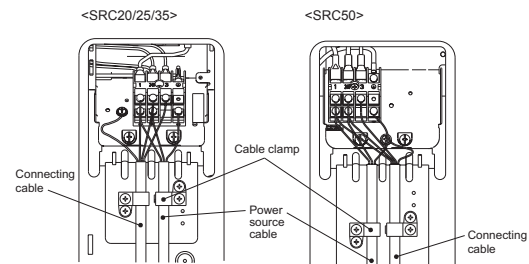
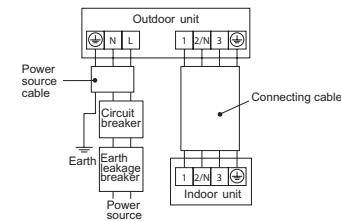

8. FINISHING WORK

1. Heating and condensation prevention

- (1) Dress the connecting pipes (both liquid and gas pipes) with insulation to prevent it from heating and dew condensation.
 - Use the heat insulating material which can withstand 120 °C or higher temperature. Make sure that insulation is wrapped tightly around the pipes and no gap is left between them.
- (2) Wrap the refrigerant pipings of indoor unit with indoor unit heat insulation using tape.
- (3) Cover the flare-connected joints (indoor side) with the indoor unit heat insulation and wrap it with an insulation pad (standard accessory provided with indoor unit).
- (4) Wrap the connecting pipes, connecting cable and drain hose with the tape.

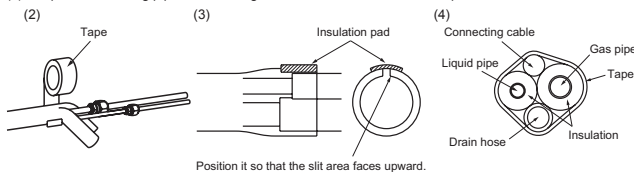

NOTE

Locations where relative humidity exceeds 70 %, both liquid and gas pipes need to be dressed with 20 mm or thicker heat insulation materials.

⚠ CAUTION

- Improper insulation can cause condensate (water) formation during cooling operation. Condensate can leak or drip causing damage to household property.
- Poor heat insulating capacity can cause pipe outer surface to reach high temperature during heating operation. It can cause cable deterioration and personal injury.

2. Finishing work

- (1) Make sure that the exterior portion of connecting pipes, connecting cable and drain hose is wrapped properly with tape. Shape the connecting pipes to match with the contours of the pipe assembly route.
- (2) Fix the pipe assembly with the wall using clamps and screws. Pipe assembly should be anchored every 1.5 m or less to isolate the vibration.
- (3) Install the service cover securely. Water may enter the unit if service cover is not installed properly, resulting in unit malfunction and failure.

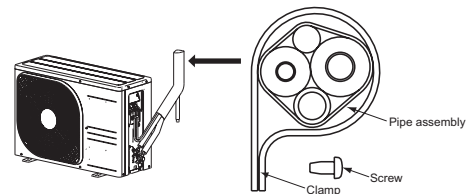

⚠ CAUTION

Make sure that the connecting pipes do not touch the components within the unit. If pipes touch the internal components, it may generate abnormal sounds and/or vibrations.

9. INSTALLATION TEST CHECK POINTS

After finishing the installation work, check the following points again before turning on the power. Conduct test run (Refer to indoor unit installation manual) and ensure that the unit operates properly.

Power source voltage complies with the rated voltage of air-conditioner.	
Earth leakage breaker and circuit breaker are installed.	
Power cable and connecting cable are securely fixed to the terminal block.	
Both liquid and gas service valves are fully open.	

No gas leaks from the joints of the service valves.	
Indoor and outdoor side pipe joints have been insulated.	
Drain hose (if installed) is fixed properly.	
Screw of the service cover is tightened properly.	

Model SRC50ZSX-W2

RWC012A063B

Model SRC20,25,35,40,50,60ZSX-W
SRC20,25,35ZSX-WA
R32 REFRIGERANT USED

- This installation manual deals with an outdoor unit installation only. For an indoor unit installation, refer to page 30.

SAFETY PRECAUTIONS

- Before installation, read the "SAFETY PRECAUTIONS" carefully and strictly follow it during the installation work in order to protect yourself.
 - The precautionary items mentioned below are distinguished into two levels, **WARNING** and **CAUTION**.
 - WARNING** Indicates a potentially hazardous situation which, if not avoided, can result in serious consequences such as death or severe injury.
 - CAUTION** Indicates a potentially hazardous situation which, if not avoided, can result in personal injury or property damage.
- Both mention the important items to protect your health and safety. Therefore, strictly follow them by any means.

WARNING

- **Be sure to use only for residential purpose.**
If this unit is installed in inferior environment such as machine shop, vehicle (like ship), warehouse, etc., it can malfunction.
- **Installation must be carried out by the qualified installer completely in accordance with the installation manual.**
Installation by non qualified person or incorrect installation can cause serious troubles such as water leak, electric shock, fire and personal injury.
- **Be sure to wear protective goggles and gloves while performing installation work.**
Improper safety measures can result in personal injury.
- **Use the original accessories and the specified components for the installation.**
Using parts other than those prescribed may cause water leak, electric shock, fire and personal injury.
- **Do not install the unit near the location where leakage of flammable gases can occur.**
If leaked gases accumulate around the unit, it can cause fire resulting in property damage and personal injury.
- **When installing the unit in small rooms, make sure that refrigerant density does not exceed the limit (Reference: ISO5149) in the event of leakage.**
If refrigerant density exceeds the limit, consult the dealer and install the ventilation system. Otherwise lack of oxygen can occur resulting in serious accident.
- **Install the unit in a location where unit will remain stable, horizontal and free of any vibration transmission.**
Unsuitable installation location can cause the unit to fall resulting in material damage and personal injury.
- **Do not run the unit with removed panels or protections.**
Touching rotating equipments, hot surfaces or high voltage parts can cause personal injury due to entrapment, burn or electric shock.
- **This unit is designed specifically for R32.**
Using any other refrigerant can cause unit failure and personal injury.
- **Do not vent R32 into atmosphere.**
R32 is a fluorinated greenhouse gas with a Global Warming Potential(GWP)=675.
- **Make sure that no air enters the refrigerant circuit when the unit is installed and removed.**
If air enters the refrigerant circuit, the pressure in the refrigerant circuit will become too high, which can cause burst and personal injury.
- **Be sure to use the prescribed pipes, flare nuts and tools for R32 or R410A.**
Using existing parts (for R22 or R407C) can cause refrigerant circuit burst resulting in unit failure and personal injury.
- **Be sure to connect both liquid and gas connecting pipes properly before operating the compressor.**
Do not open the liquid and gas service valves before completing piping work, and evacuation.
If the compressor is operated when connecting pipes are not connected and service valves are open, air can be sucked into the refrigerant circuit which can cause anomalous high pressure resulting in burst or personal injury.
- **Be sure to tighten the flare nuts to specified torque using the torque wrench.**
Tightening flare nuts with excess torque can cause burst and refrigerant leakage after a long period.
- **During pump down work, be sure to stop the compressor before closing service valves and removing connecting pipes.**
If the connecting pipes are removed when the compressor is in operation and service valves are open, air can be sucked into the refrigerant circuit which can cause anomalous high pressure resulting in burst or personal injury.
- **In the event of refrigerant leakage during installation, be sure to ventilate the working area properly.**
If the refrigerant comes into contact with naked flames, poisonous gases will be produced.
- **Electrical work must be carried out by the qualified electrician, strictly in accordance with national or regional electricity regulations.**
Incorrect installation can cause electric shock, fire or personal injury.
- **Make sure that earth leakage breaker and circuit breaker of appropriate capacities are installed.**
Circuit breaker should be able to disconnect all poles under over current. Absence of appropriate breakers can cause electric shock, personal injury or property damage.
- **Be sure to switch off the power source in the event of installation, maintenance or service.**
If the power source is not switched off, there is a risk of electric shock, unit failure or personal injury.
- **Be sure to tighten the cables securely in terminal block and relieve the cables properly to prevent overloading the terminal blocks.**
Loose connections or cable mountings can cause anomalous heat production or fire.
- **Do not process, splice or modify the power cable, or share the socket with other power plugs.**
Improper power cable or power plug can cause fire or electric shock due to poor connection, insufficient insulation or over-current.
- **Do not perform any change in protective device or its setup condition yourself.**
Changing protective device specifications can cause electric shock, fire or burst.
- **Be sure to clamp the cables properly so that they do not touch any internal component of the unit.**
If cables touch any internal component, it can cause overheating and fire.
- **Be sure to install service cover properly.**
Improper installation can cause electric shock or fire due to intrusion of dust or water.
- **Be sure to use the prescribed power and connecting cables for electrical work.**
Using improper cables can cause electric leak or fire.
- **This appliance must be connected to main power source by means of a circuit breaker or switch with a contact separation of at least 3mm.**
Improper electrical work can cause unit failure or personal injury.
- **When plugging this unit, a plug conforming to the standard IEC60884-1 must be used.**
Using improper plug can cause electric shock or fire.
- **Be sure to connect the power source cable with power source properly.**
Improper connection can cause intrusion of dust or water resulting in electric shock or fire.

CAUTION

- **Take care when carrying the unit by hand.**
If the unit weight is more than 20kg, it must be carried by two or more persons. Do not carry the unit by the plastic straps. Always use the carry handle.
- **Do not install the outdoor unit in a location where insects and small animals can inhabit.**
Insects and small animals can enter the electrical parts and cause damage resulting in fire or personal injury. Instruct the user to keep the surroundings clean.
- **If the outdoor unit is installed at height, make sure that there is enough space for installation, maintenance and service.**
Insufficient space can result in personal injury due to falling from the height.
- **Do not install the unit near the location where neighbours are bothered by noise or air generating from the unit.**
It can affect surrounding environment and cause a claim.
- **Do not install in the locations where unit is directly exposed to corrosive gases (like sulphide gas, chloride gas), sea breeze or salty atmosphere.**
It can cause corrosion of heat exchanger and damage to plastic parts.
- **Do not install the unit close to the equipments that generate electromagnetic waves and/or high-harmonic waves.**
Equipment such as inverters, standby generators, medical high frequency equipments and telecommunication equipments can affect the system, and cause malfunctions and breakdowns. The system can also affect medical equipment and telecommunication equipment, and obstruct its function or cause jamming.
- **Do not install the unit in the locations where:**
 - There are heat sources nearby.
 - Unit is directly exposed to rain or sunlight.
 - There is any obstacle which can prevent smooth air circulation from inlet and outlet side of the unit.
 - Unit is directly exposed to oil mist and steam such as kitchen.
 - Chemical substances like ammonia (organic fertilizer), calcium chloride (snow melting agent) and acid (sulfurous acid etc.), which can harm the unit, will generate or accumulate.
 - Drain water can not be discharged properly.
 - TV set or radio receiver is placed within 1m.
 - Height above sea level is more than 1000m.
- **Dispose of all packing materials properly.**
Packing materials contain nails and wood which can cause personal injury. Keep the polybag away from children to avoid the risk of suffocation.
- **Do not put anything on the outdoor unit.**
Object may fall causing property damage or personal injury.
- **Do not touch the aluminum fin of the outdoor unit.**
Aluminium fin temperature is high during heating operation. Touching fin can cause burn.
- **Do not touch any refrigerant pipe with your hands when the system is in operation.**
During operation the refrigerant pipes become extremely hot or extremely cold depending on the operating condition. Touching pipes can cause personal injury like burn (hot/cold).
- **Install isolator or disconnect switch on the power source wiring in accordance with the local codes and regulations.**
The isolator should be locked in OFF state in accordance with EN60204-1.

1. ACCESSORIES AND TOOLS

Standard accessories (Supplied with outdoor unit)		Q'ty	Locally procured parts		Tools for installation work		
(1)	Drain grommet	4	(a)	Anchor bolt(M10-M12)×4 pcs.	Plus headed driver	Spanner wrench	Vacuum pump*
(2)	Drain elbow	1	(b)	Putty	Knife	Torque wrench [14.0-62.0N·m(1.4-6.2kgf·m)]	Gauge manifold *
			(c)	Electrical tape	Saw	Wrench key (Hexagon) [4mm]	Charge hose *
			(d)	Connecting pipe			Vacuum pump adapter* (Anti-reverse flow type)
			(e)	Connecting cable	Tape measure		Gas leak detector *
			(f)	Power cable	Pipe cutter	Flare adjustment gauge	
			(g)	Clamp and screw (for finishing work)			

*Not included for SRC20, 25, or 35ZSX-WA.

*Designed specifically for R32 or R410A

2. OUTDOOR UNIT INSTALLATION

Note as a unit designed for R32

- Do not use any refrigerant other than R32. R32 will rise to pressure about 1.6 times higher than that of a conventional refrigerant. A cylinder containing R32 has a light blue indication mark on the top.
- Do not use a charge cylinder. The use of a charge cylinder will cause the refrigerant composition to change, which results in performance degradation.
- In charging refrigerant, always take it out from a cylinder in the liquid phase.
- All indoor units must be models designed exclusively for R32. Check connectable indoor unit models in a catalog, etc. (A wrong indoor unit, if connected into the system, will impair proper system operation)

1. Haulage

- Always carry or move the unit with two or more persons.
 - The right hand side of the unit as viewed from the front (outlet side) is heavier.
- A person carrying the right hand side must take care of this fact. A person carrying the left hand side must hold the handle provided on the front panel of the unit with his right hand and the corner column section of the unit with his left hand.

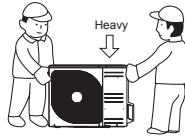

CAUTION

When a unit is hauled, take care of its gravity center position which is shifted towards right hand side. If the unit is not hauled properly, it can go off balance and fall resulting in serious injury.

2. Selecting the installation location

Select the suitable installation location where:

- Unit will be stable, horizontal and free of any vibration transmission.
- There is no obstacle which can prevent smooth air circulation from inlet and outlet side of the unit.
- There is enough space for service and maintenance of unit.
- Neighbours are not bothered by noise or air generating from the unit.
- Outlet air of the unit does not blow directly to animals or plants.
- Drain water can be discharged properly.
- There is no risk of flammable gas leakage.
- There are no other heat sources nearby.
- Unit is not directly exposed to rain or sunlight.
- Unit is not directly exposed to oil mist and steam.
- Chemical substances like ammonia (organic fertilizer), calcium chloride (snow melting agent) and acid (sulfurous acid etc.), which can harm the unit, will not generate or accumulate.
- Unit is not directly exposed to corrosive gases (like sulphide gas, chloride gas), sea breeze or salty atmosphere.
- No TV set or radio receiver is placed within 1m.
- Unit is not affected by electromagnetic waves and/or high-harmonic waves generated by other equipments.
- Strong wind does not blow against the unit outlet.
- Heavy snowfalls do not occur (If installed, provide proper protection to avoid snow accumulation).

NOTE

If the unit is installed in the area where there is a possibility of strong wind or snow accumulation, the following measures are required.

(1) Location of strong wind

- Place the unit with its outlet side facing the wall.
- Place the unit such that the direction of air from the outlet gets perpendicular to the wind direction.

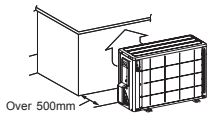

(2) Location of snow accumulation

- Install the unit on the base so that the bottom is higher than snow cover surface.
- Install the unit under eaves or provide the roof on site.

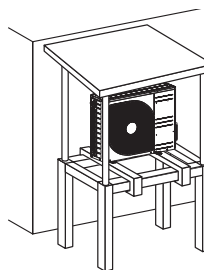

3. Installation space

- There must be 1 meter or larger space between the unit and the wall in at least 1 of the 4 sides. Walls surrounding the unit from 4 sides is not acceptable. The wall height on the outlet side should be 1200 mm or less. Refer to the following figure and table for details.

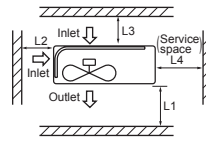

Size	Example installation (mm)			
	I	II	III	IV
L1	Open	280	280	180
L2	100	75	Open	Open
L3	100	80	80	80
L4	250	Open	250	Open

NOTE

When more than one unit are installed side by side, provide a 250mm or wider interval between them as a service space.

CAUTION

When more than one unit are installed in parallel directions, provide sufficient inlet space so that short-circuiting may not occur.

4. Drain piping work (If necessary)

Carry out drain piping work by using a drain elbow and a drain grommet supplied separately as accessories if condensed water needs to be drained out.

- Install drain elbow and drain grommet.
- Seal around the drain elbow and drain grommet with putty or adequate caulking material.

<SRC20/25/35/40/50/60ZSX-W>

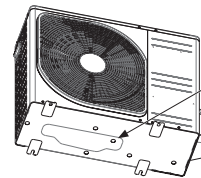

Do not put a grommet on this hole. This is a supplementary drain hole to discharge drain water, when a large amount of it is gathered.

CAUTION

Do not use drain elbow and drain grommet if there is a possibility to have several consecutive days of sub zero temperature. (There is a risk of drain water freezing inside and blocking the drain.)

<SRC20/25/35ZSX-WA>

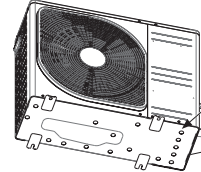

Do not block the drain holes when installing the outdoor unit.

5. Installation

- Install the unit on a flat level base.
- While installing the unit, keep space and fix the unit's legs with 4 anchor bolts as shown in the figure below. The protrusion of an anchor bolt from the foundation surface must be kept within 15mm.

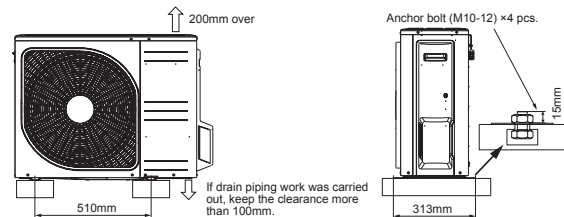

CAUTION

- Install the unit properly so that it does not fall over during earthquake, strong wind, etc.
- Make sure that unit is installed on a flat level base. Installing unit on uneven base may result in unit malfunction.

3. PREPARATION FOR WORK

1. Removing service cover

Remove the screw. Slide service cover downwards and remove it.

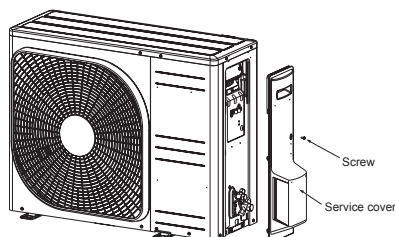

2. Removing terminal cover

Remove the screw and take out terminal cover.

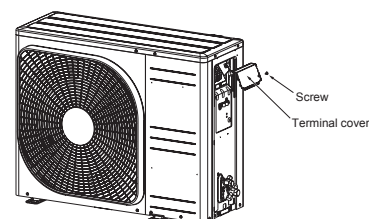

4. CONNECTING PIPING WORK

1. Restrictions on unit installation

Abide by the following restrictions on unit installation. Improper installation can cause compressor failure or performance degradation.

	Dimensional restrictions	
	Model SRC20/25/35	Model SRC40/50/60
Connecting pipe length(L)	25m or less	30m or less
Elevation difference between indoor and outdoor units(H)*	15m or less	20m or less

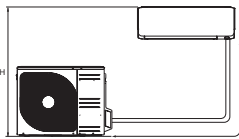

* Outdoor unit installation position can be higher as well as lower than the indoor unit installation position.

2. Preparation of connecting pipe

2.1. Selecting connecting pipe

Select connecting pipe according to the following table.

	Model SRC20/25/35	Model SRC40/50/60
Gas pipe	φ 9.52	φ 12.7
Liquid pipe	φ 6.35	φ 6.35

- Pipe wall thickness must be greater than or equal to 0.8 mm.
- Pipe material must be O-type (Phosphorus deoxidized seamless copper pipe ICS 23.040.15, ICS 77.150.30).

NOTE

If it is required to reuse the existing connecting pipe system, refer to 5. UTILIZATION OF EXISTING PIPE.

2.2. Cutting connecting pipe

- (1) Cut the connecting pipe to the required length with pipe cutter.
- (2) Hold the pipe downward and remove the burrs. Make sure that no foreign material enters the pipe.
- (3) Cover the connecting pipe ends with the tape.

3. Piping work

Check that both liquid and gas service valves are fully closed. Carry out the piping work with service valves fully closed.

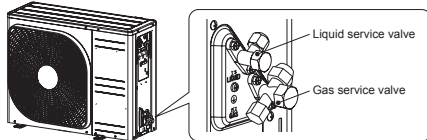

3.1. Flaring pipe

- (1) Take out flare nuts from the service valves of outdoor unit and engage them onto connecting pipes.
- (2) Flare the pipes according to table and figure shown below. Flare dimensions for R32 are different from those for conventional refrigerant. Although it is recommended to use the flaring tools designed specifically for R32 or R410A, conventional flaring tools can also be used by adjusting the measurement of protrusion B with a flare adjustment gauge.

Copper pipe outer diameter	A ₀ -0.4	Rigid (clutch) type	
		R32 or R410A	Conventional
φ 6.35	9.1	0-0.5	1.0-1.5
φ 9.52	13.2		
φ 12.7	16.6		

3.2. Connecting pipes

- (1) Connect pipes on both liquid and gas sides.
- (2) Tighten nuts to specified torque shown in the table below.

Service valve size (mm)	Tightening torque (N·m)
φ 6.35 (1/4")	14-18
φ 9.52 (3/8")	34-42
φ 12.7 (1/2")	49-61

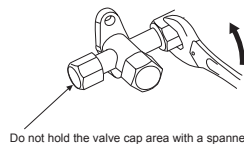

CAUTION

- Do not apply refrigerating machine oil to the flared surface. It can cause refrigerant leakage.
- Do not apply excess torque to the flared nuts. The flared nuts may crack resulting in refrigerant leakage.

4. Evacuation

- (1) Connect vacuum pump to gauge manifold. Connect charge hose of gauge manifold to service port of outdoor unit.
- (2) Run the vacuum pump for at least one hour after the vacuum gauge shows -0.1MPa (-76cm Hg).
- (3) Confirm that the vacuum gauge indicator does not rise even if the system is left for 15 minutes or more. Vacuum gauge indicator will rise if the system has moisture left inside or has a leakage point. Check the system for the leakage point. If leakage point is found, repair it and return to (1) again.
- (4) Close the Handle Lo and stop the vacuum pump. Keep this state for a few minutes to make sure that the compound pressure gauge pointer does not swing back.
- (5) Remove valve caps from liquid service valve and gas service valve.
- (6) Turn the liquid service valve's rod 90 degree counterclockwise with a hexagonal wrench key to open valve. Close it after 5 seconds, and check for gas leakage. Using soapy water, check for gas leakage from indoor unit's flare and outdoor unit's flare and valve rods. Wipe off all the water after completing the check.
- (7) Disconnect charging hose from gas service valve's service port and fully open liquid and gas service valves. (Do not attempt to turn valve rod beyond its stop.)
- (8) Tighten service valve caps and service port cap to the specified torque shown in the table below.

Service valve size (mm)	Service valve cap tightening torque (N·m)	Service port cap tightening torque (N·m)
φ 6.35 (1/4")	20-30	10-12
φ 9.52 (3/8")		
φ 12.7 (1/2")	25-35	

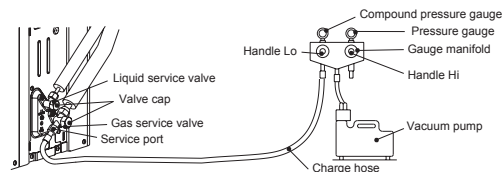

CAUTION

To prevent vacuum pump oil from entering into the refrigerant system, use a counterflow prevention adapter.

5. Additional refrigerant charge

Additional refrigerant charge is required only when connecting pipe length exceeds 15 m.

5.1 Calculating additional refrigerant charge

Additional refrigerant charge can be calculated using the formula given below.

$$\text{Additional refrigerant charge (g)} = \{ \text{Connecting pipe length (m)} - \text{Factory charged length 15 (m)} \} \times 20 \text{ (g/m)}$$

NOTE

- If additional refrigerant charge calculation result is negative, there is no need to remove the refrigerant.
- If refrigerant recharge is required for the unit with connecting pipe length 15m or shorter, charge the factory charged amount as shown in the table below.
- The maximum refrigerant charge amount is designed as shown in the table below.

	Model SRC 20/25/35	Model SRC40/50/60
The factory refrigerant charge amount(kg)	1.20	1.30
The maximum refrigerant charge amount(kg)	1.40	1.60

5.2 Charging refrigerant

- (1) Charge the R32 refrigerant in liquid phase from service port with both liquid and gas service valves shut. Since R32 refrigerant must be charged in the liquid phase, make sure that refrigerant is discharged from the cylinder in the liquid phase all the time.
- (2) When it is difficult to charge a required refrigerant amount, fully open both liquid and gas service valves and charge refrigerant, while running the unit in the cooling mode. When refrigerant is charged with the unit being run, complete the charge operation within 30 minutes.
- (3) Write the additional refrigerant charge calculated from the connecting pipe length on the label attached on the service cover.

CAUTION

- Running the unit with an insufficient quantity of refrigerant for a long time can cause unit malfunction.
- Do not charge more than the maximum refrigerant amount. It can cause unit malfunction.

5. UTILIZATION OF EXISTING PIPE

(1) Check whether an existing pipe system is reusable or not by using the following flow chart.

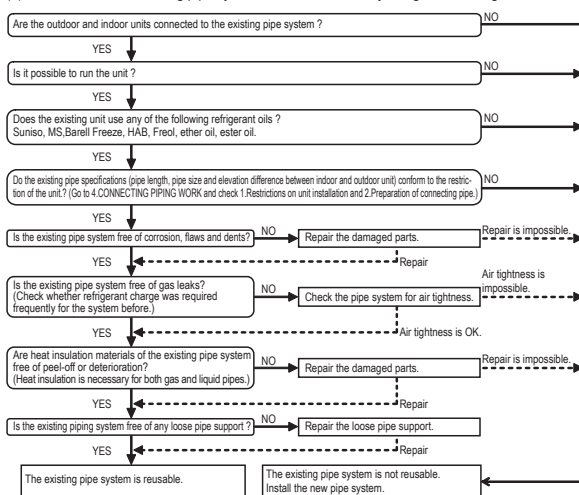

NOTE

- Consult with our distributor in the area, if you need to recover refrigerant and charge it again.
- (2) Clean the existing pipe system according to the procedure given below.
 - (a) Carry out forced cooling operation of existing unit for 30 minutes. For 'Forced cooling operation' refer to the indoor unit installation manual.
 - (b) Stop the indoor fan and carry out forced cooling operation for 3 minutes (Liquid return).
 - (c) Close the liquid service valve of the outdoor unit and carry out pump down operation (Refer to 6. PUMP DOWN).
 - (d) Blow with nitrogen gas. If discolored refrigeration oil or any foreign matter is discharged by the blow, wash the pipe system or install a new pipe system.
- (3) Remove the flare nuts from the existing pipe system. Go back to 4. CONNECTING PIPING WORK and proceed to step 2.2 Cutting connecting pipe.

CAUTION

- Do not use the old flare nuts (of existing unit). Make sure that the flare nuts supplied with the (new) outdoor unit are used.
- If the flared / compression connection to the indoor unit is located inside the house / room then this pipework can't be reused.

* If the existing piping is specified as liquid pipe φ9.52 or gas pipe φ12.7, refer to the following. (SRC40,50 and 60 only)

<Table of pipe size restrictions>

Additional charge volume per meter of pipe		0.054kg/m
Pipe size	Liquid pipe	φ9.52
	Gas pipe	φ12.7
Maximum one-way pipe length		10
Length covered without additional charge		5

Additional charge amount (kg) = (Main pipe length (m) - Length covered without additional charge shown in the table (m)) X Additional charge amount per meter of pipe shown in the table (kg/m)

6. PUMP DOWN

- Connect charge hose of gauge manifold to service port of outdoor unit.
- Close the liquid service valve with hexagonal wrench key.
- Fully open the gas service valve with hexagonal wrench key.
- Carry out forced cooling operation (For forced cooling operation procedure, refer to indoor unit installation manual).
- When the low pressure gauge becomes 0.01MPa, close the gas service valve and stop forced cooling operation.

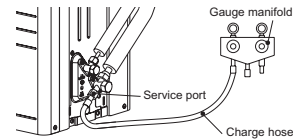

7. ELECTRICAL WIRING WORK

⚠ WARNING

- Make sure that all the electrical work is carried out in accordance with the national or regional electrical standards.
- Make sure that the earth leakage breaker and circuit breaker of appropriate capacities are installed (Refer to the table given below).
- Do not turn on the power until the electrical work is completed.
- Do not use a condensive capacitor for power factor improvement under any circumstances. (It does not improve power factor. Moreover, it can cause an abnormal overheat accident).

Breaker specifications

Model	Phase	Earth leakage breaker	Circuit breaker
SRC20/25/35	Single phase	Leakage current: 30mA, 0.1sec or less	Over current: 16A
SRC40/50/60			Over current: 20A

Main fuse specification

Model	Specification	Parts No.	Code on LABEL_WIRING
SRC20/25/35	250V 15A	SSA564A136	F7
SRC40/50/60	250V 20A	SSA564A136A	F4

1.Preparing cable

- Selecting cable
 - Select the power source cable and connecting cable in accordance with the specifications mentioned below.
 - (a) Power source cable
 - 3 cores* 2.5mm² or more, conformed with 60245 IEC57
 - When selecting the power source cable length, make sure that voltage drop is less than 2%. If the wire length gets longer, increase the wire diameter.
 - (b) Connecting cable
 - 4 cores* 1.5mm², conformed with 60245 IEC57
 - * 1 Earth wire is included (Yellow/Green).
- Arrange each wire length as shown below.
 - Make sure that each wire is stripped 10mm from the end.

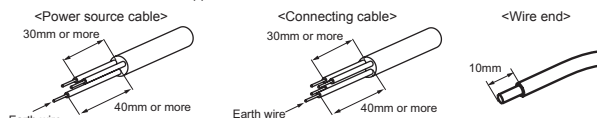

- Attach round crimp-type terminal to each wire as shown in the below.
 - Select the size of round crimp-type terminal after considering the specifications of terminal block and wire diameter.

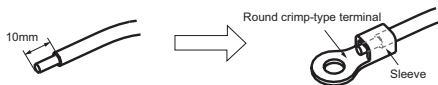

⚠ CAUTION

Power source cable and connecting cable must conform to the specifications mentioned in the manual. Using cables with wrong specifications may result in unit malfunction.

2.Connecting cable

- Remove the service cover.
- Connect the cables according to the instructions and figures given below.
 - Connect the earth wire of power source cable.
 - An earth wire must be connected before connecting the other wires of power source cable. Keep the earth wire longer than the remaining two wires of power source cable.
 - Connect the remaining two wires (N and L) of power source cable.
 - Connect the wires of connecting cable. Make sure that for each wire, outdoor and indoor side terminal numbers match.
- Fasten the cables properly with cable clamps so that no external force may work on terminal connections.
 - Moreover, make sure that cables do not touch the piping, etc. When cables are connected, make sure that all electrical components within the electrical component box are free of loose connector coupling or terminal connection.

<Circuit diagram>

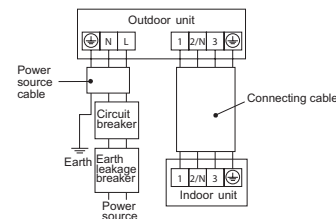

<SRC20/25/35>

<SRC40/50/60>

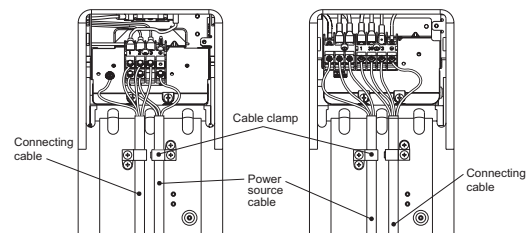

8. FINISHING WORK

1. Heating and condensation prevention

- Dress the connecting pipes (both liquid and gas pipes) with insulation to prevent it from heating and dew condensation.
 - Use the heat insulating material which can withstand 120°C or higher temperature. Make sure that insulation is wrapped tightly around the pipes and no gap is left between them.
- Wrap the refrigerant pipings of indoor unit with indoor unit heat insulation using tape.
- Cover the flare-connected joints (indoor side) with the indoor unit heat insulation and wrap it with an insulation pad (standard accessory provided with indoor unit).
- Wrap the connecting pipes, connecting cable and drain hose with the tape.

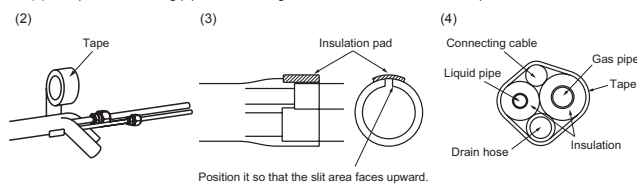

NOTE

Locations where relative humidity exceeds 70%, both liquid and gas pipes need to be dressed with 20mm or thicker heat insulation materials.

⚠ CAUTION

- Improper insulation can cause condensate(water) formation during cooling operation. Condensate can leak or drip causing damage to household property.
- Poor heat insulating capacity can cause pipe outer surface to reach high temperature during heating operation. It can cause cable deterioration and personal injury.

2.Finishing work

- Make sure that the exterior portion of connecting pipes, connecting cable and drain hose is wrapped properly with tape. Shape the connecting pipes to match with the contours of the pipe assembly route.
- Fix the pipe assembly with the wall using clamps and screws. Pipe assembly should be anchored every 1.5m or less to isolate the vibration.
- Install the service cover securely. Water may enter the unit if service cover is not installed properly, resulting in unit malfunction and failure.

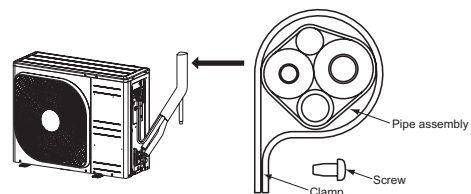

⚠ CAUTION

Make sure that the connecting pipes do not touch the components within the unit. If pipes touch the internal components, it may generate abnormal sounds and/or vibrations.

9. INSTALLATION TEST CHECK POINTS

After finishing the installation work, check the following points again before turning on the power. Conduct test run (Refer to indoor unit installation manual) and ensure that the unit operates properly.





Power source voltage complies with the rated voltage of air-conditioner.	
Earth leakage breaker and circuit breaker are installed.	
Power cable and connecting cable are securely fixed to the terminal block.	
Both liquid and gas service valves are fully open.	

No gas leaks from the joints of the service valves.	
Indoor and outdoor side pipe joints have been insulated.	
Drain hose (if installed) is fixed properly.	
Screw of the service cover is tightened properly.	

(3) Safety precautions in handling air-conditioners with flammable refrigerants

WALL TYPE AIR-CONDITIONER
R32 REFRIGERANT USED

RSA012A061B 

	This equipment uses flammable refrigerants. If the refrigerant is leaked, together with an external ignition source, there is a possibility of ignition.		There is information included in the user's manual and/or installation manual.
	The user's manual should be read carefully.		A service personnel should be handling this equipment with reference to the installation manual.

- This safety precaution sheet is for R32 refrigerant. If you want to know the type of refrigerant in the unit, check the label attached to the outdoor unit.
- The precautionary items mentioned below are distinguished into two levels, **WARNING** and **CAUTION**.

WARNING : Wrong installation would cause serious consequences such as injuries or death.

CAUTION : Wrong installation might cause serious consequences depending on circumstances.

WARNING

- Strict compliance of the domestic laws must be observed when disposing the appliance.
- Do not use means to accelerate the defrosting process or to clean, other than those recommended by the manufacturer.
- The appliance shall be stored in a room without continuously operating ignition sources (for example: open flames, an operating gas appliance or an operating electric heater).
- Do not pierce or burn.
- Be aware that refrigerants may not contain an odour.
- The indoor unit shall be stored in a room that has a minimum area of 4.0 m².

CAUTION

- General**
 - That the installation of pipe-work shall be kept to a minimum.
 - That pipe-work shall be protected from physical damage.
 - That compliance with national gas regulations shall be observed.
 - That mechanical connections shall be accessible for maintenance purposes.
 - Keep any required ventilation openings clear of obstruction.
 - Servicing shall be performed only as recommended by the manufacturer.
- Unventilated areas**
 - The appliance shall be stored in a well-ventilated area where the room size corresponds to the room area as specified for operation.
- Qualification of workers**
 - The staff in servicing operations must hold the national qualification or other relevant qualifications.
- Information on servicing**
 - Checks to the area**
 - Prior to beginning work on systems containing flammable refrigerants, safety checks are necessary to ensure that the risk of ignition is minimised.
 - For repair to the refrigerating system, 4.3 to 4.7 shall be completed prior to conducting work on the system.
 - Work procedure**
 - Work shall be undertaken under a controlled procedure so as to minimise the risk of a flammable gas or vapour being present while the work is being performed.
 - General work area**
 - All maintenance staff and others working in the local area shall be instructed on the nature of work being carried out.
 - Work in confined spaces shall be avoided.
 - The area around the workspace shall be sectioned off.
 - Ensure that the conditions within the area have been made safe by control of flammable material.
 - Checking for presence of refrigerant**
 - The area shall be checked with an appropriate refrigerant detector prior to and during work, to ensure the technician is aware of potentially toxic or flammable atmospheres.
 - Ensure that the leak detection equipment being used is suitable for use with all applicable refrigerants, i.e. non-sparking, adequately sealed or intrinsically safe.
 - Presence of fire extinguisher**
 - If any hot work is to be conducted on the refrigeration equipment or any associated parts, appropriate fire extinguishing equipment shall be available to hand. Have a dry powder or CO₂ fire extinguisher adjacent to the charging area.
 - No ignition sources**
 - No person carrying out work in relation to a refrigeration system which involves exposing any pipe work shall use any sources of ignition in such a manner that it may lead to the risk of fire or explosion.
 - All possible ignition sources, including cigarette smoking, should be kept sufficiently far away from the site of installation, repairing, removing and disposal, during which refrigerant can possibly be released to the surrounding space.
 - Prior to work taking place, the area around the equipment is to be surveyed to make sure that there are no flammable hazards or ignition risks.
 - "No Smoking" signs shall be displayed.
 - Ventilated area**
 - Ensure that the area is in the open or that it is adequately ventilated before breaking into the system or conducting any hot work.
 - A degree of ventilation shall continue during the period that the work is carried out.
 - The ventilation should safely disperse any released refrigerant and preferably expel it externally into the atmosphere.
 - Checks to the refrigeration equipment**
 - Where electrical components are being changed, they shall be fit for the purpose and to the correct specification.
 - At all times the manufacturer's maintenance and service guidelines shall be followed.
 - If in doubt consult the manufacturer's technical department for assistance.
 - The following checks shall be applied to installations using flammable refrigerants:
 - the charge size is in accordance with the room size within which the refrigerant containing parts are installed;
 - the ventilation machinery and outlets are operating adequately and are not obstructed;
 - if an indirect refrigerating circuit is being used, the secondary circuit shall be checked for the presence of refrigerant;
 - marking to the equipment continues to be visible and legible. Markings and signs that are illegible shall be corrected;
 - refrigeration pipe or components are installed in a position where they are unlikely to be exposed to any substance which may corrode refrigerant containing components, unless the components are constructed of materials which are inherently resistant to being corroded or are suitably protected against being so corroded.
 - Checks to electrical devices**
 - Repair and maintenance to electrical components shall include initial safety checks and component inspection procedures.
 - If a fault exists that could compromise safety, then no electrical supply shall be connected to the circuit until it is satisfactorily dealt with.
 - If the fault cannot be corrected immediately but it is necessary to continue operation, an adequate temporary solution shall be used.
 - This shall be reported to the owner of the equipment so all parties are advised.
 - Initial safety checks shall include:
 - that capacitors are discharged: this shall be done in a safe manner to avoid possibility of sparking;
 - that no live electrical components and wiring are exposed while charging, recovering or purging the system;
 - that there is continuity of earth bonding.
 - Repairs to sealed components**
 - During repairs to sealed components, all electrical supplies shall be disconnected from the equipment being worked upon prior to any removal of sealed covers, etc.
 - If it is absolutely necessary to have an electrical supply to equipment during servicing, then a permanently operating form of leak detection shall be located at the most critical point to warn of a potentially hazardous situation.
 - Particular attention shall be paid to the following to ensure that by working on electrical components, the casing is not altered in such a way that the level of protection is affected. This shall include damage to cables, excessive number of connections, terminals not made to original specification, damage to seals, incorrect fitting of glands, etc.
 - Ensure that the apparatus is mounted securely.
 - Ensure that seals or sealing materials have not degraded to the point that they no longer serve the purpose of preventing the ingress of flammable atmospheres.
 - Replacement parts shall be in accordance with the manufacturer's specifications.

NOTE
The use of silicon sealant can inhibit the effectiveness of some types of leak detection equipment. Intrinsically safe components do not have to be isolated prior to working on them.

⚠ CAUTION

6. Repair to intrinsically safe components

- Do not apply any permanent inductive or capacitance loads to the circuit without ensuring that this will not exceed the permissible voltage and current permitted for the equipment in use.
- Intrinsically safe components are the only types that can be worked on while live in the presence of a flammable atmosphere.
- The test apparatus shall be at the correct rating.
- Replace components only with parts specified by the manufacturer.
- Other parts may result in the ignition of refrigerant in the atmosphere from a leak.

7. Cabling

- Check that cabling will not be subject to wear, corrosion, excessive pressure, vibration, sharp edges or any other adverse environmental effects. The check shall also take into account the effects of aging or continual vibration from sources such as compressors or fans.

8. Detection of flammable refrigerants

- Under no circumstances shall potential sources of ignition be used in the searching for or detection of refrigerant leaks.
- A halide torch (or any other detector using a naked flame) shall not be used.

9. Leak detection methods

- Electronic leak detectors may be used to detect refrigerant leaks but, in the case of flammable refrigerants, the sensitivity may not be adequate, or may need re-calibration. (Detection equipment shall be calibrated in a refrigerant-free area.)
- Ensure that the detector is not a potential source of ignition and is suitable for the refrigerant used.
- Leak detection equipment shall be set at a percentage of the LFL of the refrigerant and shall be calibrated to the refrigerant employed, and the appropriate percentage of gas (25 % maximum) is confirmed.
- Leak detection fluids are suitable for use with most refrigerants but the use of detergents containing chlorine shall be avoided as the chlorine may react with the refrigerant and corrode the copper pipe-work.
- If a leak is suspected, all naked flames shall be removed/extinguished.
- If a leakage of refrigerant is found which requires brazing, all of the refrigerant shall be recovered from the system, or isolated (by means of shut off valves) in a part of the system remote from the leak.
- For appliances containing flammable refrigerants, oxygen free nitrogen (OFN) shall then be purged through the system both before and during the brazing process.

10. Removal and evacuation

- When breaking into the refrigerant circuit to make repairs – or for any other purpose – conventional procedures shall be used. However, for flammable refrigerants it is important that best practice is followed since flammability is a consideration.
- The following procedure shall be adhered to:
 - remove refrigerant;
 - purge the circuit with inert gas;
 - evacuate;
 - purge again with inert gas;
 - open the circuit by cutting or brazing.
- The refrigerant charge shall be recovered into the correct recovery cylinders.
- For appliances containing flammable refrigerants, the system shall be “flushed” with OFN to render the unit safe. This process may need to be repeated several times.
- Compressed air or oxygen shall not be used for purging refrigerant systems.

- For appliances containing flammable refrigerants, flushing shall be achieved by breaking the vacuum in the system with OFN and continuing to fill until the working pressure is achieved, then venting to atmosphere, and finally pulling down to a vacuum. This process shall be repeated until no refrigerant is within the system.
- When the final OFN charge is used, the system shall be vented down to atmospheric pressure to enable work to take place. This operation is absolutely vital if brazing operations on the pipe-work are to take place.
- Ensure that the outlet for the vacuum pump is not close to any ignition sources and that ventilation is available.

11. Charging procedures

- In addition to conventional charging procedures, the following requirements shall be followed.
 - Ensure that contamination of different refrigerants does not occur when using charging equipment. Hoses or lines shall be as short as possible to minimise the amount of refrigerant contained in them.
 - Cylinders shall be kept upright.
 - Ensure that the refrigeration system is earthed prior to charging the system with refrigerant.
 - Label the system when charging is complete (if not already).
 - Extreme care shall be taken not to overfill the refrigeration system.
- Prior to recharging the system, it shall be pressure-tested with the appropriate purging gas.
- The system shall be leak-tested on completion of charging but prior to commissioning.
- A follow up leak test shall be carried out prior to leaving the site.

12. Decommissioning

- Before carrying out this procedure, it is essential that the technician is completely familiar with the equipment and all its detail.
- It is recommended good practice that all refrigerants are recovered safely.
- Prior to the task being carried out, an oil and refrigerant sample shall be taken in case analysis is required prior to re-use of reclaimed refrigerant.
- It is essential that electrical power is available before the task is commenced.
 - a) Become familiar with the equipment and its operation.
 - b) Isolate system electrically.
 - c) Before attempting the procedure ensure that:
 - mechanical handling equipment is available, if required, for handling refrigerant cylinders;
 - all personal protective equipment is available and being used correctly;
 - the recovery process is supervised at all times by a competent person;
 - recovery equipment and cylinders conform to the appropriate standards.
 - d) Pump down refrigerant system, if possible.
 - e) If a vacuum is not possible, make a manifold so that refrigerant can be removed from various parts of the system.
 - f) Make sure that cylinder is situated on the scales before recovery takes place.
 - g) Start the recovery machine and operate in accordance with manufacturer’s instructions.
 - h) Do not overfill cylinders. (No more than 80 % volume liquid charge).
 - i) Do not exceed the maximum working pressure of the cylinder, even temporarily.
 - j) When the cylinders have been filled correctly and the process completed, make sure that the cylinders and the equipment are removed from site promptly and all isolation valves on the equipment are closed off.
 - k) Recovered refrigerant shall not be charged into another refrigeration system unless it has been cleaned and checked.

13. Labelling

- Equipment shall be labelled stating that it has been de-commissioned and emptied of refrigerant. The label shall be dated and signed.
- For appliances containing flammable refrigerants, ensure that there are labels on the equipment stating the equipment contains flammable refrigerant.

14. Recovery

- When removing refrigerant from a system, either for servicing or decommissioning, it is recommended good practice that all refrigerants are removed safely.
- When transferring refrigerant into cylinders, ensure that only appropriate refrigerant recovery cylinders are employed.
- Ensure that the correct number of cylinders for holding the total system charge are available.
- All cylinders to be used are designated for the recovered refrigerant and labelled for that refrigerant (i.e. special cylinders for the recovery of refrigerant).
- Cylinders shall be complete with pressure relief valve and associated shut-off valves in good working order.
- Empty recovery cylinders are evacuated and, if possible, cooled before recovery occurs.
- The recovery equipment shall be in good working order with a set of instructions concerning the equipment that is at hand and shall be suitable for the recovery of all appropriate refrigerants including, when applicable, flammable refrigerants.
- In addition, a set of calibrated weighing scales shall be available and in good working order.
- Hoses shall be complete with leak-free disconnect couplings and in good condition.
- Before using the recovery machine, check that it is in satisfactory working order, has been properly maintained and that any associated electrical components are sealed to prevent ignition in the event of a refrigerant release. Consult manufacturer if in doubt.
- The recovered refrigerant shall be returned to the refrigerant supplier in the correct recovery cylinder, and the relevant Waste Transfer Note arranged. Do not mix refrigerants in recovery units and especially not in cylinders.
- If compressors or compressor oils are to be removed, ensure that they have been evacuated to an acceptable level to make certain that flammable refrigerant does not remain within the lubricant.
- The evacuation process shall be carried out prior to returning the compressor to the suppliers.
- Only electric heating to the compressor body shall be employed to accelerate this process.
- When oil is drained from a system, it shall be carried out safely.

15. Other safety precautions

- A brazed, welded, or mechanical connection shall be made before opening the valves to permit refrigerant to flow between the refrigerating system parts.
- Flammable refrigerant used, refrigerant tubing protected or enclosed to avoid mechanical damage (IEC/EN 60335-2-40/A1).
- Tubing protected to extent that it will not be handled or used for carrying during moving of product (IEC/EN 60335-2-40/A1).
- Flammable refrigerant used, low temperature solder alloys, such as lead/tin alloys, not acceptable for pipe connections (IEC/EN 60335-2-40/A1).
- When there is flare connection, it must be installed outdoor.

9. OPTION PARTS



PJZ012A171

(1) Wired remote control

(a) Model RC-EX3A

1. Safety precautions

- Please read this manual carefully before starting installation work to install the unit properly. Every one of the followings is important information to be observed strictly.

 WARNING	Failure to follow these instructions properly may result in serious consequences such as death, severe injury, etc.
 CAUTION	Failure to follow these instructions properly may cause injury or property damage.

It could have serious consequences depending on the circumstances.

- The following pictograms are used in the text.

 Never do.	 Always follow the instructions given.
---	---

- Keep this manual at a safe place where you can consult with whenever necessary. Show this manual to installers when moving or repairing the unit. When the ownership of the unit is transferred, this manual should be given to a new owner.

WARNING



Consult your dealer or a professional contractor to install the unit.

Improper installation made on your own may cause electric shocks, fire or dropping of the unit.



Installation work should be performed properly according to this installation manual.

Improper installation work may result in electric shocks, fire or break-down.



Be sure to use accessories and specified parts for installation work.

Use of unspecified parts may result in drop, fire or electric shocks.



Install the unit properly to a place with sufficient strength to hold the weight.

If the place is not strong enough, the unit may drop and cause injury.



Be sure to have the electrical wiring work done by qualified electrical installer, and use exclusive circuit.

Power source with insufficient and improper work can cause electric shock and fire.



Shut OFF the main power source before starting electrical work.

Otherwise, it could result in electric shocks, break-down or malfunction.



Do not modify the unit.

It could cause electric shocks, fire, or break-down.



Be sure to turn OFF the power circuit breaker before repairing/ inspecting the unit.

Repairing/inspecting the unit with the power circuit breaker turned ON could cause electric shocks or injury.

 **WARNING**

Do not install the unit in appropriate environment or where inflammable gas could generate, flow in, accumulate or leak.



If the unit is used at places where air contains dense oil mist, steam, organic solvent vapor, corrosive gas (ammonium, sulfuric compound, acid, etc) or where acidic or alkaline solution, special spray, etc. are used, it could cause electric shocks, break-down, smoke or fire as a result of significant deterioration of its performance or corrosion.

Do not install the unit where water vapor is generated excessively or condensation occurs.



It could cause electric shocks, fire, or break-down.

Do not use the unit in a place where it gets wet, such as laundry room.



It could cause electric shocks, fire, or break-down.

Do not operate the unit with wet hands.



It could cause electric shocks.

Do not wash the unit with water.



It could cause electric shocks, fire, or break-down.

Use the specified cables for wiring, and connect them securely with care to protect electronic parts from external forces.



Improper connections or fixing could cause heat generation, fire, etc.

Seal the inlet hole for remote control cable with putty.



If dew, water, insect, etc. enters through the hole, it could cause electric shocks, fire or break-down.

If dew or water enters the unit, it may cause screen display anomalies.

When installing the unit at a hospital, telecommunication facility, etc., take measures to suppress electric noises.



It could cause malfunction or break-down due to hazardous effects on the inverter, private power generator, high frequency medical equipment, radio communication equipment, etc.

The influences transmitted from the remote control to medical or communication equipment could disrupt medical activities, video broadcasting or cause noise interference.

Do not leave the remote control with its upper case removed.



If dew, water, insect, etc. enters through the hole, it could cause electric shocks, fire or break-down.

 **CAUTION****Do not install the remote control at following places.**

- (1) It could cause break-down or deformation of remote control.
- Where it is exposed to direct sunlight
 - Where the ambient temperature becomes 0 °C or below, or 40 °C or above
 - Where the surface is not flat
 - Where the strength of installation area is insufficient
- (2) Moisture may be attached to internal parts of the remote control, resulting in a display failure.
- Place with high humidity where condensation occurs on the remote control
 - Where the remote control gets wet
- (3) Accurate room temperature may not be detected using the temperature sensor of the remote control.
- Where the average room temperature cannot be detected
 - Place near the equipment to generate heat
 - Place affected by outside air in opening/closing the door
 - Place exposed to direct sunlight or wind from air-conditioner
 - Where the difference between wall and room temperature is large



To connect to a personal computer via USB, use the dedicated software.**Do not connect other USB devices and the remote control at the same time.**

It could cause malfunction or break-down of the remote control/personal computer.

2 . Accessories & Prepare on site

Following parts are provided.

Accessories	R/C main unit, wood screw (ø3.5 x 16) 2 pcs, Quick reference
-------------	--

Following parts are arranged at site. Prepare them according to the respective installation procedures.

Item name	Q'ty	Remark
Switch box For 1 piece or 2 pieces (JIS C 8340 or equivalent)	1	These are not required when installing directly on a wall.
Thin wall steel pipe for electric appliance directly on a wall. (JIS C 8305 or equivalent)	As required	
Lock nut, bushing (JIS C 8330 or equivalent)	As required	
Lacing (JIS C 8425 or equivalent)	As required	Necessary to run R/C cable on the wall.
Putty	Suitably	For sealing gaps
Molly anchor	As required	
R/C cable (0.3 mm ² x 2 pcs)	As required	See right table when longer than 100 m

When the cable length is longer than 100 m, the max size for wires used in the R/C case is 0.5mm². Connect them to wires of larger size near the outside of R/C. When wires are connected, take measures to prevent water, etc. from entering inside.

≦ 200 m	0.5 mm ² x 2 cores
≦ 300m	0.75 mm ² x 2 cores
≦ 400m	1.25 mm ² x 2 cores
≦ 600m	2.0 mm ² x 2 cores

3 . Installation place

Secure the installation space shown in the figure.

For the installation method, "embedding wiring" or "exposing wiring" can be selected.

For the wiring direction, "Backward", "Upper center" or "Upper left" can be selected.

Determine the installation place in consideration of the installation method and wiring direction.

Installation space

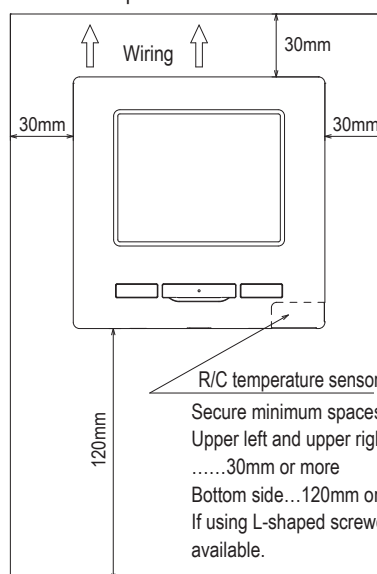

R/C temperature sensor

Secure minimum spaces for disassembling the case.
Upper left and upper right sides
.....30mm or more
Bottom side...120mm or more
If using L-shaped screwdriver, 50mm or more is available.

4 . Installation procedure

Perform installation and wiring work for the remote control according to the following procedure.

Dimensions (Viewed from front)

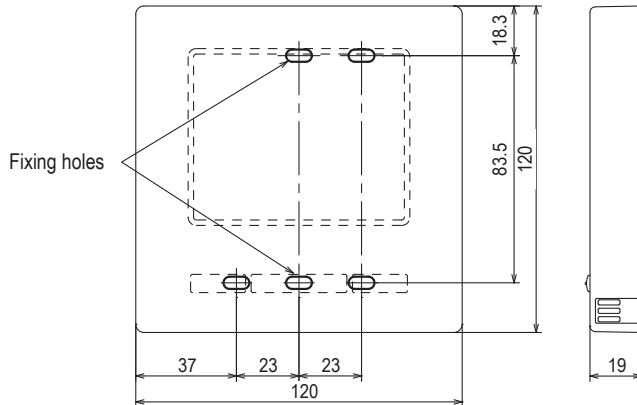

To disassemble the R/C case into the upper and lower pieces after assembling them once

- Insert the tip of flat head screwdriver or the like in the recess at the lower part of R/C and twist it lightly to remove. It is recommended that the tip of the screwdriver be wrapped with tape to avoid damaging the case.

Take care to protect the removed upper case from moisture or dust.

In case of embedding wiring

(When the wiring is retrieved "Backward")

① Embed the switch box and the R/C wires beforehand.

Seal the inlet hole for the R/C wiring with putty.

PCB side (Viewed from rear)

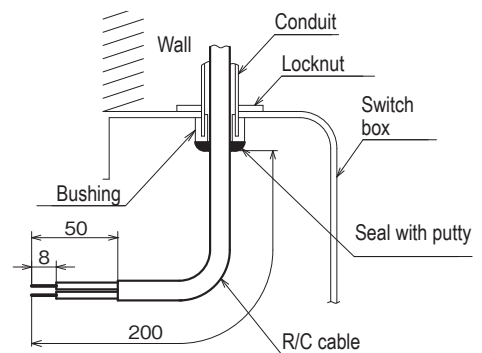
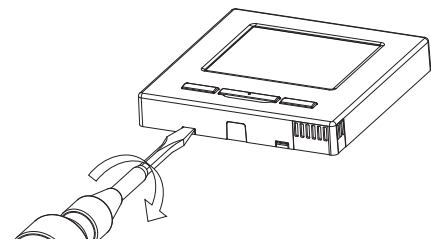
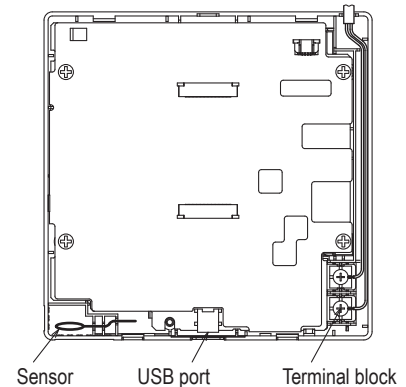

② When wires are passed through the bottom case, fix the bottom case at 2 places on the switch box.

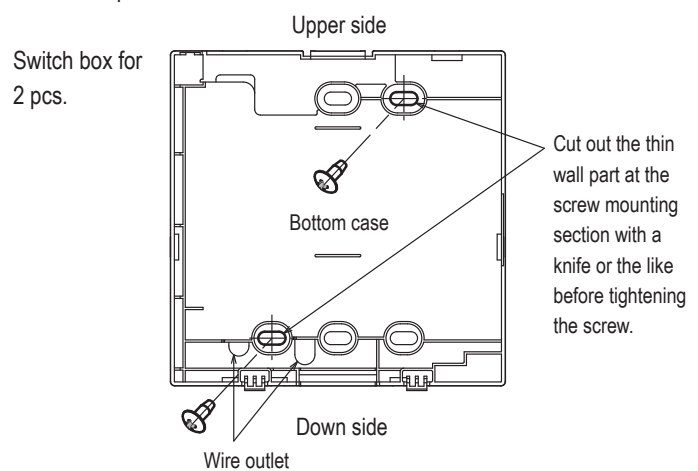
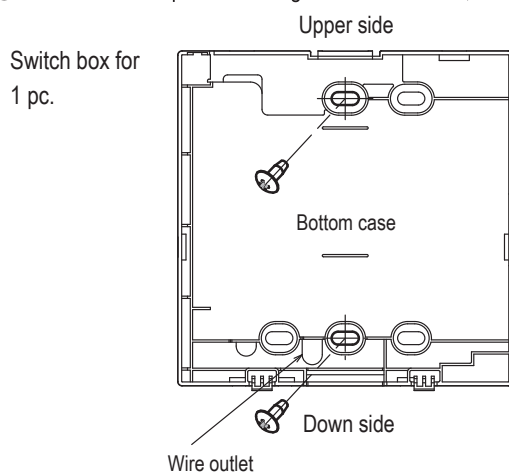

- ③ Connect wires from X and Y terminals of R/C to X and Y terminals of indoor unit. R/C wires (X, Y) have no polarity. Fix wires such that the wires will run around the terminal screws on the top case of R/C.
- ④ Install the upper case with care not to pinch wires of R/C.

Cautions for wire connection

Use wires of no larger than 0.5mm² for wiring running through the remote control case. Take care not to pinch the sheath.

Tighten by hand (0.7N·m or less) the wire connection. If the wire is connected using an electric driver, it may cause failure or deformation.

In case of exposing wiring

(When the wiring is taken out from the “upper center” or “upper left” of R/C)

- ① Cut out the thin wall sections on the cases for the size of wire.

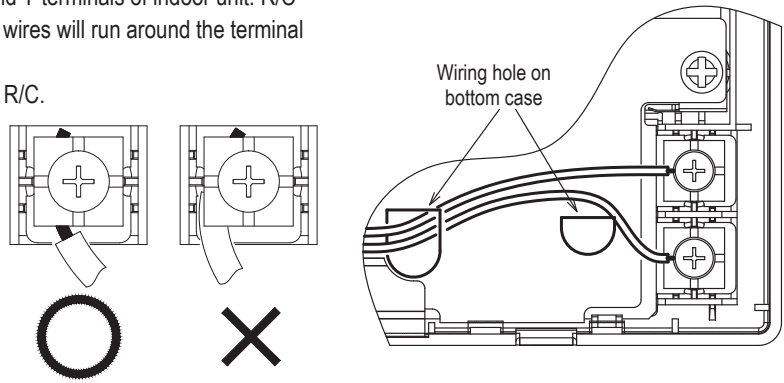

When taking the wiring out from the upper center, open a hole before separating the upper and bottom cases. This will reduce risk of damaging the PCB and facilitate subsequent work.
 When taking the wiring out from the upper left, take care not to damage the PCB and not to leave any chips of cut thin wall inside.

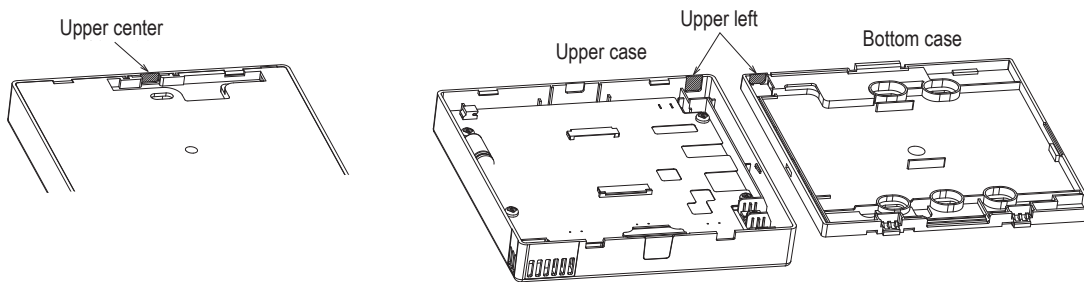

- ② Fix the bottom R/C case on a flat surface with two wood screws.
- ③ In case of the upper center, pass the wiring behind the bottom case. (Hatched section)
- ④ Connect wires from X and Y terminals of R/C to X and Y terminals of indoor unit. R/C wires (X, Y) have no polarity. Fix wires such that the wires will run around the terminal screws on the top case of R/C.
- ⑤ Install the top case with care not to pinch wires of R/C.
- ⑥ Seal the area cut in ① with putty.

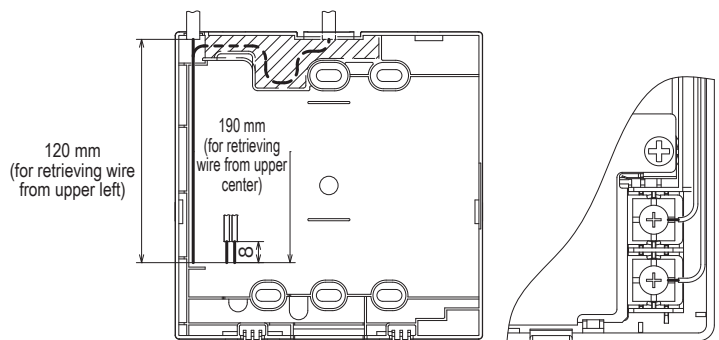

5 . Main/Sub setting when more than one remote control are used

Up to two units of R/C can be used at the maximum for 1 indoor unit or 1 group.

One is main R/C and the other is sub R/C.

Operating range is different depending on the main or sub R/C.

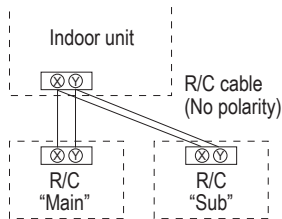

R/C operations		Main	Sub	
Run/Stop, Change set temp., Change flap direction, Auto swing, Change fan speed operations		○	○	
High power operation, Energy-saving operation		○	○	
Silent mode control		○	×	
Useful functions	Individual flap control	○	×	
	Anti draft setting	○	×	
	Timer	○	○	
	Favorite setting	○	○	
	Weekly timer	○	×	
	Home leave mode	○	×	
	External ventilation	○	○	
	Select the language	○	○	
	Silent mode control	○	×	
	Energy-saving setting		○	×
Filter	Filter sign reset	○	○	
User setting	Initial settings		○	○
	Administrator settings	Permission/Prohibition setting	○	×
		Outdoor unit silent mode timer	○	×
	Setting temp. range		○	×
	Temp increment setting		○	×
	Set temp. display		○	○
	R/C display setting		○	○
	Change administrator password		○	○
	F1/F2 function setting		○	○

○ : operable × : not operable

R/C operations		Main	Sub			
Service setting	Installation settings	Installation date	○	×		
		Company information	○	○		
		Test run	○	×		
		Static pressure adjustment	○	×		
		Change auto-address	○	×		
		Address setting of main IU	○	×		
		IU back-up function	○	×		
		Motion sensor setting	○	×		
		R/C function settings	Main/Sub of R/C	○	○	
			Return air temp.	○	×	
	R/C sensor		○	×		
	R/C sensor adjustment		○	×		
	Operation mode		○	×		
	°C / °F		○	×		
	Fan speed		○	×		
	External input		○	×		
	Upper/lower flap control		○	×		
	Left/right flap control		○	×		
	IU settings	Ventilation setting	○	×		
		Auto-restart	○	×		
		Auto temp. setting	○	×		
		Auto fan speed	○	×		
		IU settings		○	×	
		Service & Maintenance	IU address		○	○
			Next service date		○	×
			Operation data		○	×
			Error display	Error history	○	○
				Display/erase anomaly data	○	×
	Reset periodical check			○	○	
	Saving IU settings		○	×		
	Special settings		Erase IU address		○	×
			CPU reset		○	○
			Restore of default setting		○	×
		Touch panel calibration		○	○	
	Indoor unit capacity display		○	×		

Advice: Connection to personal computer

It can be set from a personal computer via the USB port (mini-B).
Connect after removing the cover for USB port of upper case.
Replace the cover after use.
Special software is necessary for the connection.
For details, view the web site.

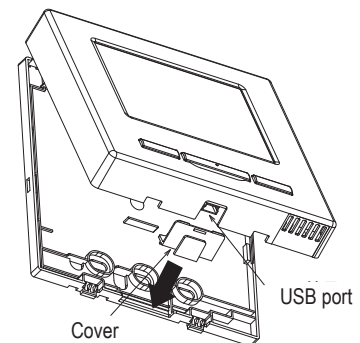

Advice: Initializing of password

Administrator password (for daily setting items) and service password (for installation, test run and maintenance) are used.

- The administrator password at factory default is "0000". This setting can be changed (Refer to User's Manual).

If the administrator password is forgotten, it can be initialized by holding down the [F1] and [F2] switches together for five seconds on the administrator password input screen.

- Service password is "9999", which cannot be changed.
When the administrator password is input, the service password is also accepted.

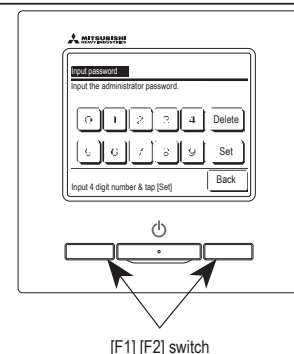



(b) Model RC-E5

PJA012D730 

Read together with indoor unit's installation manual.



 **WARNING**

- Fasten the wiring to the terminal securely and hold the cable securely so as not to apply unexpected stress on the terminal.
Loose connection or hold will cause abnormal heat generation or fire. 
- Make sure the power source is turned off when electric wiring work.
Otherwise, electric shock, malfunction and improper running may occur. 

 **CAUTION**

- Do not install the remote control at the following places in order to avoid malfunction.

(1) Places exposed to direct sunlight	(4) Hot surface or cold surface enough to generate condensation
(2) Places near heat devices	(5) Places exposed to oil mist or steam directly
(3) High humidity places	(6) Uneven surface

- Do not leave the remote control without the upper case.
In case the upper case needs to be detached, protect the remote control with a packaging box or bag in order to keep it away from water and dust. 

Accessories	Remote control, wood screw ($\phi 3.5 \times 16$) 2 pieces
Prepare on site	Remote control cord (2 cores) the insulation thickness in 1 mm or more. [In case of embedding cord] Electrical box, M4 screw (2 pieces) [In case of exposing cord] Cord clamp (if needed)

Installation procedure

- ① Open the cover of remote control, and remove the screw under the buttons without fail.
- ② Remove the upper case of remote control.
Insert a flat-blade screwdriver into the dented part of the upper part of the remote control, and wrench slightly.

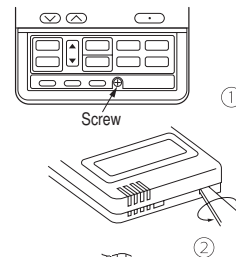

[In case of embedding cord]

- ③ Embed the electrical box and remote control cord beforehand.

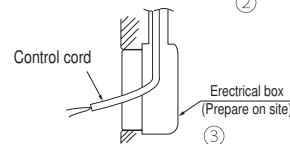

- ④ Prepare two M4 screws (recommended length is 12-16mm) on site, and install the lower case to electrical box. Choose either of the following two positions in fixing it with screws.

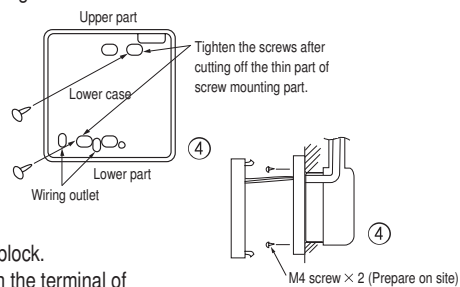
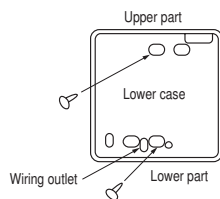

- ⑤ Connect the remote control cord to the terminal block.
Connect the terminal of remote control (X,Y) with the terminal of indoor unit (X,Y). (X and Y are no polarity)
- ⑥ Install the upper case as before so as not to catch up the remote control cord, and tighten with the screws.

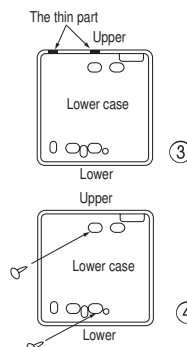

[In case of exposing cord]

- ③ You can pull out the remote control cord from left upper part or center upper part.
Cut off the upper thin part of remote control lower case with a nipper or knife, and grind burrs with a file etc.
- ④ Install the lower case to the flat wall with attached two wooden screws.

- ⑤ Connect the remote control cord to the terminal block. Connect the terminal of remote control (X,Y) with the terminal of indoor unit (X,Y). (X and Y are no polarity) Wiring route is as shown in the right diagram depending on the pulling out direction.

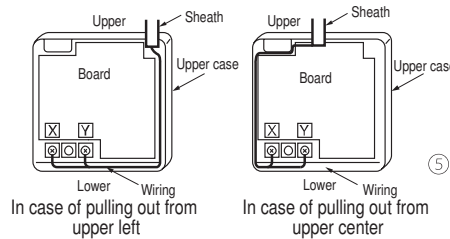

The wiring inside the remote control case should be within 0.3mm² (recommended) to 0.5mm². The sheath should be peeled off inside the remote control case. The peeling-off length of each wire is as below.

Pulling out from upper left	Pulling out from upper center
X wiring : 215mm	X wiring : 170mm
Y wiring : 195mm	Y wiring : 190mm

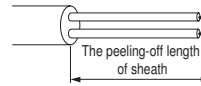

- ⑥ Install the upper case as before so as not to catch up the remote control cord, and tighten with the screws.
- ⑦ In case of exposing cord, fix the cord on the wall with cord clamp so as not to slack.

Installation and wiring of remote control

- ① Wiring of remote control should use 0.3mm² × 2 core wires or cables. (on-site configuration)
- ② Maximum prolongation of remote control wiring is 600m. If the prolongation is over 100m, change to the size below. But, wiring in the remote control case should be under 0.5mm². Change the wire size outside of the case according to wire connecting. Waterproof treatment is necessary at the wire connecting section. Be careful about contact failure.
 - 100 - 200m.....0.5mm² × 2 cores
 - Under 300m.....0.75mm² × 2 cores
 - Under 400m.....1.25mm² × 2 cores
 - Under 600m.....2.0mm² × 2 cores

Master/ slave setting when more than one remote controls are used

A maximum of two remote controls can be connected to one indoor unit (or one group of indoor units.)

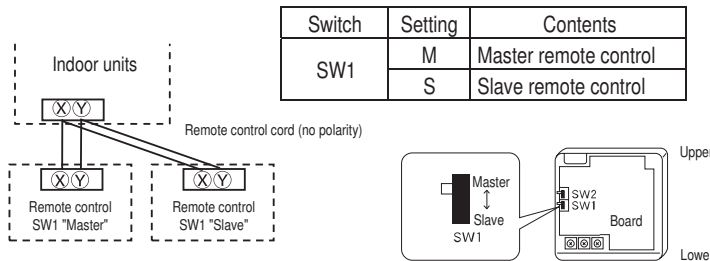

Set SW1 to "Slave" for the slave remote control. It was factory set to "Master" for shipment. Note: The setting "Remote control sensor enabled" is only selectable with the master remote control in the position where you want to check room temperature. The air-conditioner operation follows the last operation of the remote control regardless of the master/ slave setting of it.

The indication when power source is supplied

When power source is turned on, the following is displayed on the remote control until the communication between the remote control and indoor unit settled.

Master remote control : " ⌚ WAIT ⌚ " "M"
 Slave remote control : " ⌚ WAIT ⌚ " "S"

At the same time, a mark or a number will be displayed for two seconds first. This is the software's administration number of the remote control, not an error cord.



*: The left mark is only an example. Other marks may appear.

When remote control cannot communicate with the indoor unit for half an hour, the below indication will appear. Check wiring of the indoor unit and the outdoor unit etc.



The range of temperature setting

When shipped, the range of set temperature differs depending on the operation mode as below.

- Heating : 16-30°C (55-86°F)
- Except heating (cooling, fan, dry, automatic) : 18-30°C (62-86°F)

●Upper limit and lower limit of set temperature can be changed with remote control.

Upper limit setting: valid during heating operation. Possible to set in the range of 20 to 30°C (68 to 86°F).
 Lower limit setting: valid except heating (automatic, cooling, fan, dry) Possible to set in the range of 18 to 26°C (62 to 79°F).
 When you set upper and lower limit by this function, control as below.

1. When ⑫ TEMP RANGE SET, remote control function of function setting mode is "INDN CHANGE" (factory setting),
 [If upper limit value is set]
 During heating, you cannot set the value exceeding the upper limit.
 [If lower limit value is set]
 During operation mode except heating, you cannot set the value below the lower limit.
2. When ⑫ TEMP RANGE SET, remote control function of function setting mode is "NO INDN CHANGE"
 [If upper limit value is set]
 During heating, even if the value exceeding the upper limit is set, upper limit value will be sent to the indoor unit.
 But, the indication is the same as the temperature set.
 [If lower limit value is set]
 During except heating, even if the value lower than the lower limit is set, lower limit value will be sent to the indoor unit.
 But, the indication is the same as the temperature set.

●How to set upper and lower limit value

1. Stop the air-conditioner, and press (SET) and (MODE) button at the same time for over three seconds .
 The indication changes to "FUNCTION SET ▼".
2. Press button once, and change to the "TEMP RANGE ▲" indication.
3. Press (SET) button, and enter the temperature range setting mode.
4. Select "UPPER LIMIT ▼" or "LOWER LIMIT ▲" by using button.
5. Press (SET) button to fix.
6. When "UPPER LIMIT ▼" is selected (valid during heating)
 - ① Indication: " ^ SET UP" → "UPPER 30°C ^"
 - ② Select the upper limit value with temperature setting button . Indication example: "UPPER 26°C ^" (blinking)
 - ③ Press (SET) button to fix. Indication example: "UPPER 26°C" (Displayed for two seconds)
 After the fixed upper limit value displayed for two seconds, the indication will return to "UPPER LIMIT ▼".
7. When "LOWER LIMIT ▲" is selected (valid during cooling, dry, fan, automatic)
 - ① Indication: " ^ SET UP" → "LOWER 18°C ^"
 - ② Select the lower limit value with temperature setting button . Indication example: "LOWER 24°C ^" (blinking)
 - ③ Press (SET) button to fix. Indication for example: "LOWER 24°C" (Displayed for two seconds)
 After the fixed lower limit value displayed for two seconds, the indication will return to "LOWER LIMIT ▼".
8. Press button to finish.

• It is possible to finish by pressing button on the way, but unfinished change of setting is unavailable.

• During setting, if you press (RESET) button, you return to the previous screen.

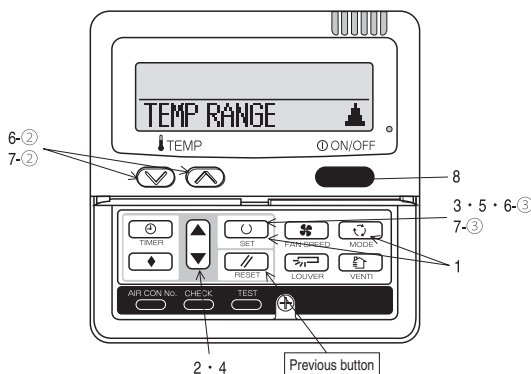

The functional setting

● The initial function setting for typical using is performed automatically by the indoor unit connected, when remote control and indoor unit are connected.
 As long as they are used in a typical manner, there will be no need to change the initial settings.
 If you would like to change the initial setting marked "○", set your desired setting as for the selected item.
 The procedure of functional setting is shown as the following diagram.

[Flow of function setting]

Start : Stop air-conditioner and press "○" (SET) and "◀▶" (MODE) buttons at the same time for over three seconds.
 Finalize : Press "○" (SET) button.
 Reset : Press "⏮" (RESET) button.
 Select : Press "▲▼" button.
 End : Press "ON/OFF" button.

It is possible to finish above setting on the way, and unfinished change of setting is unavailable.
 "○": Initial settings
 "※": Automatic criterion

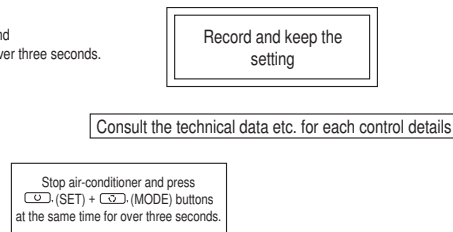

To next page

FUNCTION SET (Remote control function)

Function	setting	
*01 ESP SET	ESP VALID	○ Validate setting of ESP: External Static Pressure
	ESP INVALID	○ Invalidate setting of ESP
02 AUTO RUN SET	AUTO RUN ON	※ Automatic operation is impossible
	AUTO RUN OFF	※
03 TEMP SW	VALID	○ Temperature setting button is not working
	INVALID	○
04 MODE SW	VALID	○ Mode button is not working
	INVALID	○
05 ON/OFF SW	VALID	○ On/Off button is not working
	INVALID	○
06 FAN SPEED SW	VALID	○ Fan speed button is not working
	INVALID	○
07 LOUVER SW	VALID	○ Louver button is not working
	INVALID	○
08 TIMER SW	VALID	○ Timer button is not working
	INVALID	○
*09 SENSOR SET	SENSOR OFF	○ Remote sensor is not working.
	SENSOR ON	○ Remote sensor is working.
	SENSOR +3.0℃	○ Remote sensor is working, and to be set for producing +3.0°C increase in temperature.
	SENSOR +2.0℃	○ Remote sensor is working, and to be set for producing +2.0°C increase in temperature.
	SENSOR +1.0℃	○ Remote sensor is working, and to be set for producing +1.0°C increase in temperature.
	SENSOR -1.0℃	○ Remote sensor is working, and to be set for producing -1.0°C increase in temperature.
	SENSOR -2.0℃	○ Remote sensor is working, and to be set for producing -2.0°C increase in temperature.
	SENSOR -3.0℃	○ Remote sensor is working, and to be set for producing -3.0°C increase in temperature.
10 AUTO RESTART	INVALID	○
	VALID	○
*11 VENT LINK SET	NO VENT	○ In case of Single split series, by connecting ventilation device to CnT of the indoor printed circuit board (in case of VRF series, by connecting it to CnD of the indoor printed circuit board), the operation of ventilation device is linked with the operation of indoor unit.
	VENT LINK	○ In case of Single split series, by connecting ventilation device to CnT of the indoor printed circuit board (in case of VRF series, by connecting it to CnD of the indoor printed circuit board), you can operate /stop the ventilation device independently by (VENT) button.
	NO VENT LINK	○
12 TEMP RANGE SET	INDOOR CHANGE	○ If you change the range of set temperature, the indication of set temperature will vary following the control.
	NO INDOOR CHANGE	○ If you change the range of set temperature, the indication of set temperature will not vary following the control, and keep the set temperature.
13 FAN POSITION	HI-HLD-LO	※ Air flow of fan becomes of HI-HLD-LO or the four speed of HI-HLD-LO.
	HI-LO	※ Air flow of fan becomes of HI-LO.
	HI-HLD	※ Air flow of fan becomes of HI-HLD.
	1 FAN SPEED	※ Air flow of fan is fixed at one speed.
14 POSITION	POSITION STOP	○ If you change the remote control function "14 POSITION", you must change the indoor function "04 POSITION" accordingly. You can select the louver stop position in the four.
	FREE STOP	○ The louver can stop at any position.
15 MODEL TYPE	HEAT PUMP	※
	COOLING ONLY	※
16 EXTERNAL CONTROL SET	INDIVIDUAL	○ If you input signal into CnT of the indoor printed circuit board from external, the indoor unit will be operated independently according to the input from external.
	FOR ALL UNITS	○ If you input into CnT of the indoor printed circuit board from external, all units which connect to the same remote control are operated according to the input from external.
17 ROOM TEMP INDICATION SET	INDICATION OFF	○ In normal working indication, indoor unit temperature is indicated instead of air flow.
	INDICATION ON	○ (Only the master remote control can be indicated.)
18 INDICATION	INDICATION ON	○ Heating preparation indication should not be indicated.
	INDICATION OFF	○
19 °C/°F SET	°C	○ Temperature indication is by degree C
	°F	○ Temperature indication is by degree F

To next page

Note (1)*The mark cannot use SRF series.

ON/OFF button (finished)

Note 1: The initial setting marked "※" is decided by connected indoor and outdoor unit, and is automatically defined as following table.

Function No.	Item	Default	Model
Remote control function02	AUTO RUN SET	AUTO RUN ON	"Auto-RUN" mode selectable indoor unit.
		AUTO RUN OFF	Indoor unit without "Auto-RUN" mode
Remote control function06	FAN SPEED SW	INVALID	Indoor unit with two or three step of air flow setting
		INVALID	Indoor unit with only one of air flow setting
Remote control function07	LOUVER SW	VALID	Indoor unit with automatically swing louver
		INVALID	Indoor unit without automatically swing louver
Remote control function13	I/U FAN	HI-MED-LO	Indoor unit with three step of air flow setting
		HI-LO	Indoor unit with two step of air flow setting
		1 FAN SPEED	Indoor unit with only one of air flow setting
Remote control function15	MODEL TYPE	HEAT PUMP	Heat pump unit
		COOLING ONLY	Exclusive cooling unit

Note 3: As for plural indoor unit, set indoor functions to each master and slave indoor unit.
But only master indoor unit is received the setting change of indoor unit function "05 EXTERNAL INPUT" and "06 PERMISSION / PROHIBITION".

From previous page

Indoor unit No. are indicated only when plural indoor units are connected.

To set other indoor unit, press [AIR CON No.] button, which allows you to go back to the indoor unit selection screen (for example: I/U 000 ▲).

Function	setting	
*02 FAN SPEED SET	STANDARD	※
	HIGH SPEED 1	※
	HIGH SPEED 2	
*03 FILTER SIGN SET	INDICATION OFF	
	TYPE 1	○
	TYPE 2	
	TYPE 3	
	TYPE 4	
04 POSITION	POSITION STOP	○
	FREE STOP	
05 EXTERNAL INPUT	LEVEL INPUT	○
	PULSE INPUT	
06 PERMISSION/PROHIBITION	INVALID	○
	VALID	
*07 EMERGENCY STOP	INVALID	○
	VALID	
*08 ※ SP OFFSET	OFFSET +3.0℃	
	OFFSET +2.0℃	
	OFFSET +1.0℃	
	NO OFFSET	○
*09 RETURN AIR TEMP	OFFSET +2.0℃	
	OFFSET +1.5℃	
	OFFSET +1.0℃	
	NO OFFSET	○
	OFFSET -1.0℃	
	OFFSET -1.5℃	
	OFFSET -2.0℃	
*10 ※ FAN CONTROL	LOW FAN SPEED	○
	SET FAN SPEED	
	INTERMITTENCE	
	FAN OFF	
*11 FROST PREVENTION TEMP	TEMP HIGH	
	TEMP LOW	○
*12 FROST PREVENTION CONTROL	FAN CONTROL ON	○
	FAN CONTROL OFF	
*13 DRAIN PUMP LINK	※○	○
	※○AND※	
	※○AND※AND※	
	※○AND※	
*14 ※ FAN REMAINING	NO REMAINING	○
	0.5 HOUR	
	1 HOUR	
	6 HOUR	
*15 ※ FAN REMAINING	NO REMAINING	○
	0.5 HOUR	
	2 HOUR	
	6 HOUR	
*16 ※ FAN INTERMITTENCE	NO REMAINING	○
	2min OFF 5min ON	
	5min OFF 5min ON	
*17 PRESSURE CONTROL	STANDARD	※
	TYPE 1	※

Note2: Fan setting of "HIGH SPEED"

Fan tap	Indoor unit air flow setting				
	UH - Hi - Me - Lo	Hi - Me - Lo	Hi - Lo	Hi - Me	
FAN SPEED SET	STANDARD	UH - Hi - Me - Lo	Hi - Me - Lo	Hi - Lo	Hi - Me
	HIGH SPEED1, 2	UH - UH - Hi - Me	UH - Hi - Me	UH - Me	UH - Hi

Initial function setting of some indoor unit is "HIGH SPEED".
4 speed is not able to be set with wireless remote control.

The filter sign is indicated after running for 180 hours.
The filter sign is indicated after running for 600 hours.
The filter sign is indicated after running for 1000 hours.
The filter sign is indicated after running for 1000 hours, then the indoor unit will be stopped by compulsion after 24 hours.

If you change the indoor function "04 POSITION", you must change the remote control function "14 POSITION" accordingly.
You can select the lower stop position in the four.
The louver can stop at any position.

Permission/prohibition control of operation will be valid.

With the VRF series, it is used to stop all indoor units connected with the same outdoor unit immediately.
When stop signal is inputted from remote on-off terminal "CnT-6", all indoor units are stopped immediately.

To be reset for producing +3.0℃ increase in temperature during heating.
To be reset for producing +2.0℃ increase in temperature during heating.
To be reset for producing +1.0℃ increase in temperature during heating.

To be reset producing +2.0℃ increase in return air temperature of indoor unit.
To be reset producing +1.5℃ increase in return air temperature of indoor unit.
To be reset producing +1.0℃ increase in return air temperature of indoor unit.

To be reset producing -1.0℃ increase in return air temperature of indoor unit.
To be reset producing -1.5℃ increase in return air temperature of indoor unit.
To be reset producing -2.0℃ increase in return air temperature of indoor unit.

When heating thermostat is OFF, fan speed is low speed.
When heating thermostat is OFF, fan speed is set speed.

When heating thermostat is OFF, fan speed is operated intermittently.
When heating thermostat is OFF, the fan is stopped.
When the remote sensor is working, "FAN OFF" is set automatically.
Do not set "FAN OFF" when the indoor unit's sensor is working.

Change of indoor heat exchanger temperature to start frost prevention control.

Working only with the single split series.
To control frost prevention, the indoor fan tap is raised.

Drain pump is run during cooling and dry.
Drain pump is run during cooling, dry and heating.
Drain pump is run during cooling, dry, heating and fan.
Drain pump is run during cooling, dry and fan.

After cooling is stopped, the fan does not perform extra operation.
After cooling is stopped, the fan perform extra operation for half an hour.
After cooling is stopped, the fan perform extra operation for an hour.
After cooling is stopped, the fan perform extra operation for six hours.

After heating is stopped or heating thermostat is OFF, the fan does not perform extra operation.
After heating is stopped or heating thermostat is OFF, the fan perform extra operation for half an hour.
After heating is stopped or heating thermostat is OFF, the fan perform extra operation for two hours.
After heating is stopped or heating thermostat is OFF, the fan perform extra operation for six hours.

During heating is stopped or heating thermostat is OFF, the fan perform intermittent operation for five minutes with low fan speed after twenty minutes' OFF.
During heating is stopped or heating thermostat is OFF, the fan perform intermittent operation for five minutes with low fan speed after five minutes' OFF.

Connected "OA Processing" type indoor unit, and is automatically defined.

From previous page

How to set function

1. Stop air-conditioner and press (SET) (MODE) buttons at the same time for over three seconds, and the "FUNCTION SET ▼" will be displayed.



2. Press (SET) button.
3. Make sure which do you want to set, "FUNCTION ▼" (remote control function) or "I/U FUNCTION ▲" (indoor unit function).
4. Press ▲ or ▼ button.
Select "FUNCTION ▼" (remote control function) or "I/U FUNCTION ▲" (indoor unit function).

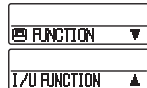

5. Press (SET) button.

【On the occasion of remote control function selection】

- ① "DATA LOADING" (Indication with blinking)
↓
Display is changed to "01 ESP SET".
- ② Press ▲ or ▼ button.
"No. and function" are indicated by turns on the remote control function table, then you can select from them.
(For example)

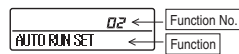

- ③ Press (SET) button.
The current setting of selected function is indicated.
(for example) "AUTO RUN ON" ← If "02 AUTO RUN SET" is selected



- ④ Press ▲ or ▼ button.
Select the setting.

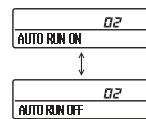

- ⑤ Press (SET) button.
"SET COMPLETE" will be indicated, and the setting will be completed.
Then after "No. and function" indication returns, Set as the same procedure if you want to set continuously, and if to finish, go to 7.



7. Press (ON/OFF) button.
Setting is finished.

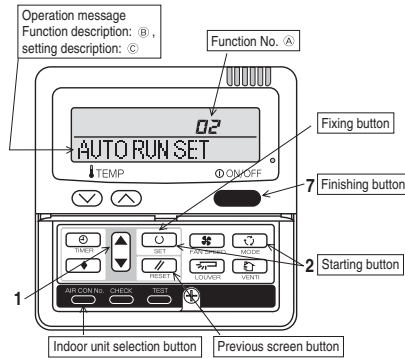

【On the occasion of indoor unit function selection】

- ① "DATA LOADING" (Blinking for 2 to 23 seconds to read the data)
↓
Indication is changed to "02 FAN SPEED SET".
Go to ②.

[Note]

- (1) If plural indoor units are connected to a remote control, the indication is "I/U 000" (blinking) ← The lowest number of the indoor unit connected is indicated.

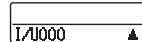

- ② Press ▲ or ▼ button.
Select the number of the indoor unit you are to set.
If you select "ALL UNIT ▼", you can set the same setting with all unites.
- ③ Press (SET) button.
- ④ Press ▲ or ▼ button.
"No. and function" are indicated by turns on the indoor unit function table, then you can select from them.
(For example)

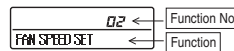

- ⑤ Press (SET) button.
The current setting of selected function is indicated.
(For example) "STANDARD" ← If "02 FAN SPEED SET" is selected.

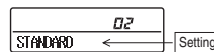

- ④ Press ▲ or ▼ button.
Select the setting.
- ⑤ Press (SET) button.
"SET COMPLETE" will be indicated, and the setting will be completed.
Then after "No. and function" indication returns, set as the same procedure if you want to set continuously, and if to finish, go to 7.



※ When plural indoor units are connected to a remote control, press the (AIR CON No.) button, which allows you to go back to the indoor unit selection screen. (example "I/U 000 ▲")

- It is possible to finish by pressing (ON/OFF) button on the way, but unfinished change of setting is unavailable.
- During setting, if you press (RESET) button, you return to the previous screen.
- Setting is memorized in the control and it is saved independently of power failure.

【How to check the current setting】

When you select from "No. and function" and press set button by the previous operation, the "Setting" displayed first is the current setting.
(But, if you select "ALL UNIT ▼", the setting of the lowest number indoor unit is displayed.)

(c) Operation and setting from wired remote control

Blank : Not compatible
 - : No function on remote control
 ○ : Correspondence
 △ : Corresponding part

Setting & display item		Description	RC-EX3A	RC-E5	
1.Remote control network					
1	Control plural indoor units by a single remote control	A remote control can control plural indoor units up to 16 (in one group of remote control network). An address is set to each indoor unit.	○	○	
2	Main/sub setting of remote controls	A pair of remote controls (including optional wireless remote control) can be connected within the remote control network. Set one to "Main" and the other to "Sub".	○	○	
2.TOP screen, Switch manipulation					
1	Menu	"Control", "State", or "Details" can be selected. (3-8)	○	-	
2	Operation mode	"Cooling", "Heating", "Fan", "Dry" or "Auto" can be set.	○	○	
3	Set temp.	"Set temperature" can be set by 0.5°C interval.	○	○	
4	Air flow direction	"Air flow direction" [Individual flap control] can be set. Select Enable or Disable for the "3D AUTO".	○	△	
5	Fan speed	"Fan speed" can be set.	○	○	
6	Timer setting	"Timer operation" can be set.	○	○	
7	ON/OFF	"On/Off operation of the system" can be done.	○	○	
8	F1 SW	The system operates and is controlled according to the function specified to the F1 switch.	○	-	
9	F2 SW	The system operates and is controlled according to the function specified to the F2 switch.	○	-	
3.Useful functions					
1	Individual flap control	The moving range (the positions of upper limit and lower limit) of the flap for individual flap can be set.			
2	Anti draft setting When the panel with the anti-draft function is assembled.	When the panel with the anti draft function is assembled, select to Enable or Disable the anti draft setting for each operation mode and for each blow outlet.			
3	Timer settings	Set On timer by hour	The period of time to start operation after stopping can be set. • The period of set time can be set within range of 1hour-12hours (1hr interval). • The operation mode, set temp. and fan speed at starting operation can be set.	△	-
		Set Off timer by hour	The period of time to stop operation after starting can be set. • The period of set time can be set within range of 1hour-12hours (1hr interval).	○	○
		Set On timer by clock	The clock time to start operation can be set. • The set clock time can be set by 5 minutes interval. • [Once (one time only)] or [Everyday] operation can be switched. • The operation mode, set temp and fan speed at starting operation can be set.	△	○
		Set Off timer by clock	The clock time to stop operation can be set. • The set clock time can be set by 5 minutes interval. • [Once (one time only)] or [Everyday] operation can be switched.	○	○
	Confirmation of timer settings	Status of timer settings can be seen.	○	-	
4	Favorite setting [Administrator password]	Set the operation mode, setting temperature, air flow capacity and air flow direction for the choice setting operations. Set them for the Favorite set 1 and the Favorite set 2 respectively.	○	-	
5	Weekly timer	On timer and Off timer on weekly basis can be set. • 8-operation patterns per day can be set at a maximum. • The setting clock time can be set by 5 minutes interval. • Holiday setting is available. • The operation mode, set temp and fan speed at starting operation can be set.	○	○	
6	Home leave mode [Administrator password]	When leaving home for a long period like a vacation leave, the unit can be operated to maintain the room temperature not to be hotter in summer or not to be colder in winter. • The judgment to switch the operation mode (Cooling ↔ Heating) is done by the both factors of the set temp. and outdoor air temp. • The set temp. and fan speed can be set.	○	-	
7	External Ventilation When the ventilator is combined.	On/Off operation of the external ventilator can be done. It is necessary to set from [Menu] ⇒ [Service setting] ⇒ [R/C function settings] ⇒ [Ventilation setting]. • If the "Independent" is selected for the ventilation setting, the ventilator can be operated or stopped.	○	○	
8	Select the language	Select the language to display on the remote control. • Select from English, German, French, Spanish, Italian, Dutch, Turkish, Portuguese, Russian, Polish, Japanese and Chinese.	○	-	
9	Look, look	Indoor temperature, outdoor temperature and power consumption are indicated.	△	-	
10	Power consumption indication	The power consumption of today, this week and this year is indicated by a chart. It is possible to compare with yesterday, last week and last year. • This item may not indicate depending on indoor and outdoor units which are combined.	○	-	
4.Energy-saving setting					
1	Sleep timer	To prevent the timer from keeping ON, set hours to stop operation automatically with this timer. • The selectable range of setting time is from 30 to 240 minutes. (10 minutes interval) • When setting is "Enable", this timer will activate whenever the ON timer is set.	○	-	
2	Peak-cut timer	Power consumption can be reduced by restructuring the maximum capacity. Set the [Start time], the [End time] and the capacity limit % (Peak-cut %). • 4-operation patterns per day can be set at maximum. • The setting time can be changed by 5-minutes interval. • The selectable range of capacity limit % (Peak-cut %) is from 0% to 40-80% (20% interval). • Holiday setting is available.	○	-	
3	Automatic temp. set back	After the elapse of the set time period, the current set temp. will be set back to the [Set back time]. • The setting can be done in cooling and heating mode respectively. • Selectable range of the set time is from 20 min. to 120 min. (10 min. interval). • Set the [Set back temp.] by 1°C interval.	○	-	
4	Infrared sensor control (Motion sensor control) When the panel with the infrared sensor (motion sensor) is assembled.	When the infrared sensor (motion sensor) is used, it is necessary to set Enable or Disable for the "Power control" and the "Auto-off".			
5.Filter					
1	Filter sign reset	Filter sign reset	The filter sign can be reset.		
		Setting next cleaning date	The next cleaning date can be set.		
6.User setting					
1	Internal settings	Clock setting	The current date and time can be set or revised. • If a power failure continues no longer than 80 hours, the clock continues to tick by the built-in power source.	○	-
		Date and time display	[Display] or [Hide] the date and/or time can be set, and [12H] or [24H] display can be set.	○	-
		Summer time	When select [Enable], the +1hour adjustment of current time can be set. When select [Disable], the [Summer time] adjustment can be reset.	○	-
		Contrast	The contrast of LCD can be adjusted higher or lower.	○	-
		Backlight	Switching on/off a light can be set and period of the lighting time can be set within the range of 5sec-90 sec (5sec interval).	○	-
		Control sound	It can set with or without [Control sound (beep sound)] at touch panel.	○	-
	Operation lamp luminance	This is used to adjust the luminance of operation lamp.	○	-	

Setting & display item		Description	RC-EX3A	RC-E5
2 Administrator settings [Administrator password]	Permission/Prohibition setting	• Permission/Prohibition setting of operation can be set. [On/Off] [Change set temp] [Change operation mode] [Change flap direction] [Change fan speed] [High power operation] [Energy-saving operation] [Timer] Request for administrator can be set. [Individual flap control] [Weekly timer] [Select the language] [Anti draft setting]	○	—
	Outdoor unit silent mode timer	The period of time to operate the outdoor unit by prioritizing the quietness can be set. • The [Start time] and the [End time] for operating outdoor unit in silent mode can be set. • The period of the operation time can be set once a day by 5 minutes interval.	○	○
	Setting temp. range	The upper/lower limit of temp. setting range can be set. • The limitation of indoor temp. setting range can be set for each operation mode in cooling and heating.	○	○
	Temp increment setting	The temp. increment setting can be changed by 0.5°C or 1.0°C.	○	○
	Set temp. display	Ways of displaying setting temperatures can be selected.	○	○
	R/C display setting	Register [Room name] [Name of I/U] Display [Indoor temp. display] or not. Display [Error code display] or not. Display [Heating stand-by display] [Defrost operation display] [Auto cooling/heating display] [Display temp of R/C, Room, Outdoor] or not	○	—
	Change administrator password	The administrator password can be changed. (Default setting is "0000") The administrator password can be reset.	○ ○	—
F1/F2 function setting	Functions can be set for F1 and F2. Selectable functions: [High power operation], [Energy-saving operation], [Silent mode cont.], [Home leave mode], [Favorite set 1], [Favorite set 2] and [Filter sign reset].	○	—	
7. Service setting				
1 Installer settings [Service password]	Installation date	The [Installation date] can be registered. • When registering the [Installation date], the [Next service date] is displayed automatically. (For changing the [Next service date], please refer the item of [Service & Maintenance])	○	—
	Company information	The [Company information] can be registered and can be displayed on the R/C. • The [Company] can be registered within 26 characters. • The [Phone No.] can be registered within 13 digits.	○	—
	Test run	On/Off operation of the test run can be done.		
		The [Cooling test run] can be done at 5°C of set temp. for 30 minutes.	○	○
	Drain pump test run	Only drain pump can be operated.		
	Static pressure adjustment	In case of combination with only the ducted indoor unit which has a function of static pressure adjustment, the static pressure is adjustable. • It can be set for each indoor unit individually.		—
	Change auto-address	The set address of each indoor unit decided by auto-address setting method can be changed to any other address.		—
	Address setting of main IU	Main indoor unit address can be set. • Only the Main indoor unit can change operation mode and the Sub indoor units dominated by the Main indoor shall follow. • The Main indoor unit can domain 10 indoor units at a maximum.		—
IU back-up function	When a pair of indoor units (2 groups) is connected to one unit of remote control, it can be set Enable or Disable for the [IU rotation], [IU capacity back-up] and [IU fault back-up]	○	—	
Infrared sensor setting (Motion sensor setting) When the panel with the infrared sensor (motion sensor) is assembled.	Set Enable or Disable for the infrared sensor detectors of indoor units connected to the remote control. If Disable is selected, it cannot be control the infrared sensor control for the energy-saving setting.	○	—	
Grill lifting operation	Set enable for automatic lifting panel operation. When automatic lifting panel is assembled.			
2 R/C function setting [Service password]	Main/Sub R/C	The R/C setting of [Main/Sub] can be changed.	○	—
	Return air temp.	When two or more indoor units are connected to one unit of remote control, suction sensors, which are used for the judgement by thermostat, can be selected. • It can be selected from [Individual], [Master IU] and [Average temp].	○	—
	R/C sensor	It can be set the mode to switch to the remote control sensor. It can be selected from cooling and heating.	○	△
	R/C sensor adjustment	The offset value of [R/C sensor] sensing temp. can be set respectively in heating and cooling.	○	△
	Operation mode	Enable or Disable can be set for each operation mode.	○	△
	°C / °F	Set the unit for setting temperatures. • °C or °F can be selected.	○	○
	Fan speed	Fan speeds can be selected.	○	—
	External input	When two or more indoor units are connected to one unit of remote control, the range to apply CnT inputs can be set.	○	○
	Upper/lower flap control	[Stop at fixed position] or [Stop at any position] can be selected for the upper and lower louvers.	○	○
	Left/right flap control	[Fixed position stop] or [Stop at any position] can be selected for the right and left louvers.	○	—
	Ventilation setting	Combination control for ventilator can be set.	○	○
	Auto-restart	The operation control method after recovery of power failure happened during operation can be set.	○	○
	Auto temp. setting	[Enable] or [Disable] of [Auto temp. setting] can be selected.	○	—
Auto fan speed	[Enable] or [Disable] of [Auto fan speed] can be selected.	○	—	
3 IU settings [Service password]	Fan speed setting	The fan speed for indoor units can be set.		
	Filter sign	The setting of filter sign display timer can be done from following patterns.		—
	External input 1	The connect of control by external input 1 can be changed.	△	△
	External input 1 signal	The type of external input 1 signal can be changed.	○	○
	External input 2	The connect of control by external input 2 can be changed.		—
	External input 2 signal	The type of external input 2 signal can be changed.		—
	Heating thermo-OFF temp. adjustment	The judgement temp. of heating thermo-off can be adjusted within the range from 0 to +3°C (1°C interval).		
	Return temperature adjustment	The sensing temp. of return air temp. sensor built in the indoor unit can be adjusted within the range of ±2°C.		
	Fan control in cooling thermo-OFF	Fan control, when the cooling thermostat is turned OFF, can be changed.		
	Fan control in heating thermo-OFF	Fan control, when the heating thermostat is turned OFF, can be changed.	△	△
	Anti-frost temp.	Judgment temperature for the anti-frost control during cooling can be changed.		
	Anti-frost control	When the anti-frost control of indoor unit in cooling is activated, the fan speed can be changed.		
	Drain pump operation	In any operation mode in addition to cooling and dry mode, the setting of drain pump operation can be done.		
	Keep fan operating after cooling is stopped	The time period residual fan operation after stopping or thermo-off in cooling mode can be set.		
	Keep fan operating after heating is stopped	The time period residual fan operation after stopping or thermo-off in heating mode can be set.		
	Intermittent fan operation in heating	The fan operation rule following the residual fan operation after stopping or thermo-off in heating mode can be set.		
	Fan circulator operation	In case that the fan is operated as the circulator, the fan control rule can be set.		
	Control pressure adjust	When only the OA processing units are operated, control pressure value can be changed.		
	Auto operation mode	The [Auto rule selection] for switching the operation mode automatically can be selected from 3 patterns.		
	Thermo. rule setting	When selecting [Outdoor air temp. control], the judgment temp can be offset by outdoor temp..		
	Auto fan speed control	Auto switching range for the auto fan speed control can be set.		
	IU overload alarm	If the difference between the setting temperature and the suction temperature becomes larger than the temperature difference set for the overload alarm, at 30 minutes after the start of operation, the overload alarm signal is transmitted from the external output (CnT-5).	○	—
	External output setting *1	Functions assigned to the external outputs 1 to 4 can be changed.	△	—

Setting & display item		Description	RC-EX3A	RC-E5
4. Service & Maintenance [Service password]	IU address	Max 16 indoor units can be connected to one remote control, and all address No. of the connected indoor units can be displayed. • The indoor unit conforming to the address No. can be identified by selecting the address No. and tapping [Check] to operate the indoor fan.	○	—
	Next service date	The [Next service date] can be registered. • The [Next service date] and [Company information] is displayed on the message screen.	○	—
	Operation data	The [Operation data] for indoor unit and outdoor unit can be displayed.	○	○
	Error display			
	Error history	The error history can be displayed.		
	Display anomaly data	The operation data just before the latest error stop can be displayed.	○	△
	Erase anomaly data	Anomaly operation data can be erased.		
	Reset periodical check	The timer for the periodical check can be reset.		
	Saving IU settings	The IU settings memorized in the indoor PCB connected to the remote control can be saved in the memory of the remote control.	○	—
	Special settings	[Erase IU address] [CPU reset] [Restore of default setting] [Touch panel calibration]	○	△
	Indoor unit capacity display	Address No. and capacities of indoor units connected to the remote control are displayed.	○	—
8. Contact company		Shows registered [Contact company] and [Contact phone].	○	—
9. Inspection				
Confirmation of Inspection		This is displayed when any error occurs.	○	—
10. PC connection				
USB connection		Weekly timer setting and etc., can be set from PC.	○	—

◆ Listed items may not function depending on the specifications of indoor and outdoor units which are combined.

*1 It supports only following functions.

Operation output / Heating output / Compressor ON output / Inspection (Error) output / Cooling output / Fan operation output 1 / Fan operation output 2 / Fan operation output 3 / Defrost/oil return output

(2) Interface kit (SC-BIKN2-E)

RKZ012A099

Accessories included in package

Be sure to check all the accessories included in package.

No.	Part name	Quantity
①	Indoor unit's connection cable (cable length: 1.8m)	1
②	Wood screws (for mounting the interface: ø4x 25)	2
③	Tapping screws (for the cable clamp and the interface mounting bracket)	3
④	Interface mounting bracket	1
⑤	Cable clamp (for the indoor unit's connection cable)	1
⑥	CnT terminal connection cable (total cable length: 0.5m)	1

Safety precautions

Before use, please read these Safety precautions thoroughly before installation.

- All the cautionary items mentioned below are important safety related items to be taken into consideration, so be sure to observe them at all times.

Warning Incorrect installation could lead to serious consequences such as death, major injury or environmental destruction.

- Symbols used in these precautions

! Always go along these instruction.

- After completed installation, carry out trial operation to confirm no anomaly, and ask the user to keep this installation manual in a good place for future reference.

Warnings



- **Installation must be carried out by a qualified installer.**
If you install it by yourself, it may cause an electric shock, fire and personal injury, as a result of a system malfunction.
- **Install it in full accordance with the installation manual.**
Incorrect installation may cause an electric shock, fire and personal injury.
- **Electrical work must be carried out by a qualified electrician in accordance with the technical standard for electrical equipment, the indoor wiring standard and this installation manual.**
Incorrect installation may cause an electric shock, fire and personal injury.
- **Use the specific cables for wiring. And connect all the cables to terminals or connectors securely and clamp them with cable clamps in order for external forces not to be transmitted to the terminals directly.**
Incomplete connection may cause malfunction, and lead to heat generation and fire.
- **Use the original accessories and specified components for installation.**
If the parts other than those prescribed by us are used, it may cause an electric shock, fire and personal injury.

Connecting the indoor unit's connection cable to the interface

- ① Remove the upper case of the interface.
 - Remove 2 screws from the interface casing before removal of upper casing.
- ② Connect the indoor unit's connection cable to the interface.
 - Connect the connector of the indoor unit connection cable to the connector on the interface's circuit board.
- ③ Fix the indoor unit's connection cable with the cable clamp.
 - Cable can be brought in from the top or from the back.
 - Cut out the punch-outs for the connection cables running into the casing with cutter.
- ④ Connect the indoor unit's connection cable to the indoor unit control PCB.
 - Connect the indoor unit's connection cable to the indoor unit control PCB securely.
 - Clamp the connection cable to the indoor control box securely with the cable clamp provided as an accessory.
 - Regarding the cable connection to the indoor unit, refer to the installation manual for indoor unit.

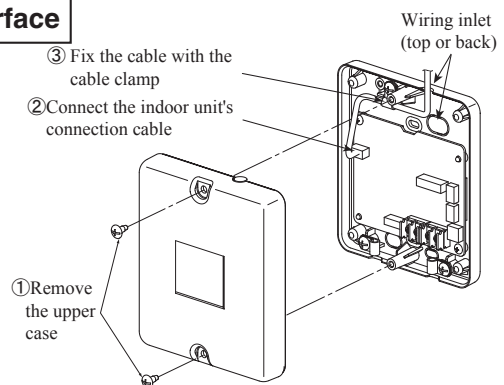

Name of each part of the interface

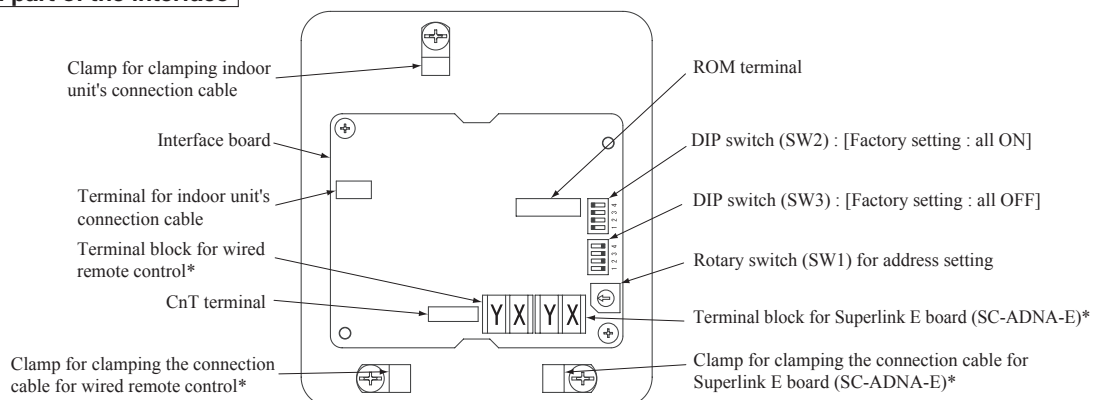

*Either the connection cables of Superlink E board (SC-ADNA-E) or of wired remote control is connectable.

Switch	Setting	Function	Switch	Setting	Function
SW2-1	ON**	CnT level input	SW2-3	ON**	External input (CnT input)
	OFF	CnT pulse input		OFF	Operation permission/prohibition (CnT input)
SW2-2	ON**	Wired remote control : Enable	SW2-4	ON**	Annual cooling : Enable***
	OFF	Wired remote control : Disable		OFF	Annual cooling : Disable***

** Factory setting

*** Indoor fan control at low outdoor air temperature in cooling

Installation of the interface

- Install the interface within the range of the connection cable length (approximately 1.3m) from the indoor unit.
- Be sure not to extend the connection cable on site. If the connection cable is extended, malfunction may occur.
- Fix the interface on the wall, pillar or the like.

● Don't install the interface and wired remote control at the following places.

- Places exposed to direct sunlight
- Places near heating devices
- High humidity places
- Surfaces where are enough hot or cold to generate condensation
- Places exposed to oil mist or steam directly
- Uneven surface

Mounting the interface directly on a wall

- ① Mount the lower casing of the interface on a flat surface with wood screws provided as standard accessory.
- ② Mount the upper casing.

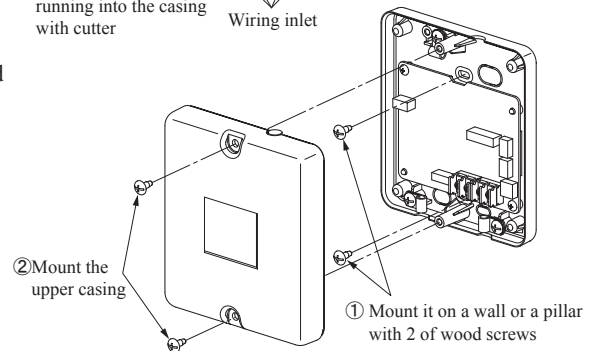
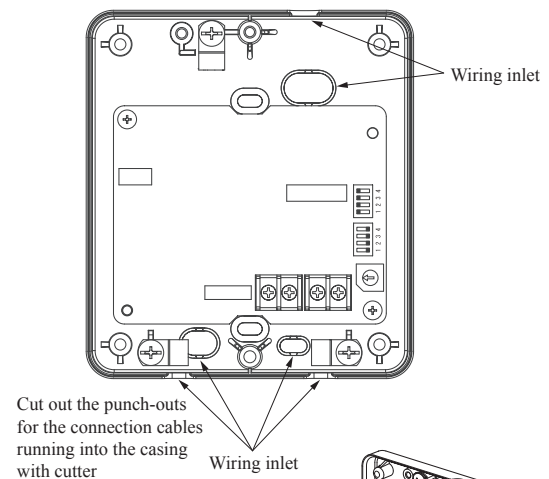

Recessing the interface in the wall

- ① Recess the electrical box (procured locally) and connection cables in the wall.
- ② Mount the lower casing of the interface to the electrical box with M4 screws (procured locally).
- ③ Mount the upper casing.

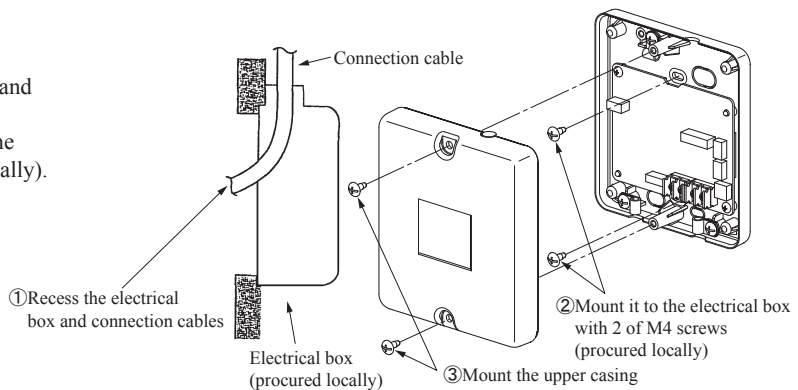

Mounting the interface with the mounting bracket

- ① Mount the upper casing.
- ② Mount the mounting bracket to the interface with tapping screws provided as standard accessory.
- ③ Mount the mounting bracket on wall or the like with wood screws provided as standard accessory.

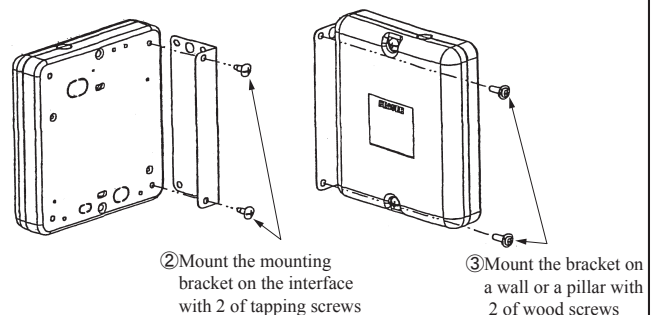

Installation check items

- Are the connection cables connected securely to the terminal blocks and connectors?
- Are the thickness and length of the connection cables conformed with the standard?

Functions of CnT connector

It is available to operate the air-conditioner and to monitor the operation status with the external control unit (remote display) by sending the input/output signal through CnT connector on the indoor unit control PCB.

- ① Connect a external remote control unit (procured locally) to CnT terminal.
- ② In case of the pulse input, switch OFF the DIP switch SW2-1 on the interface PCB.
- ③ When setting operation permission/prohibition mode, switch OFF the DIP switch SW2-3 on the interface PCB.

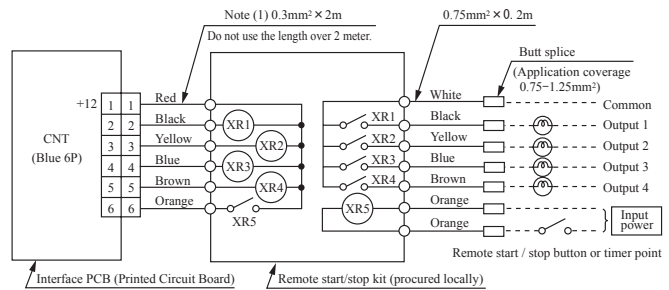

Input/Output	Function	Output signal		Content
		Relay	ON/OFF	
Output 1	Operation output	XR1	ON	During air-conditioner operation
Output 2	Heating output	XR2	ON	During heating operation
Output 3	Compressor operation output	XR3	ON	During compressor running
Output 4	Malfunction output	XR4	ON	During anomalous stop

- XR1-4 are for the DC 12V relay
- XR5 is a DC 12/24V or AC 220-240V relay
- CnT connector (local) maker, model

Connector	Molex	5264-06
Terminals	Molex	5263T

Input/Output	Function	SW2-1		SW2-3		Air-conditioner	Operation by remote control				
		Setting		Input signal	Content						
Input	External control input	ON*	Level input	ON*		Level	OFF→ON	External input	ON	Allowed	
					Level	ON→OFF	Operation permission	OFF			
				Level	OFF→ON	Operation permission	OFF				
				Level	ON→OFF	Operation prohibition	OFF				
		OFF	Pulse input	ON*	Pulse	ON*	Level	OFF→ON	External input	OFF→ON	Allowed
							Level	ON→OFF	Operation permission	ON	
				Level	OFF→ON	Operation permission	ON				
				Level	ON→OFF	Operation prohibition	OFF				

* Factory setting

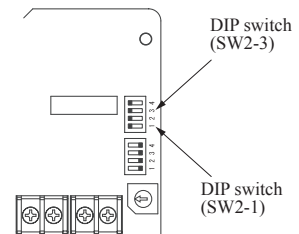

In case of the remote control (RC-EX3A or later model), the external outputs (1 – 4) and the external input can be changed using the function setting of remote control. For the setting method, refer to the installation manual. Also refer to the technical manual to know how it is adapted to the function setting for the external outputs and input, at the indoor unit side.

Connection of Superlink E board

Regarding the connection of Superlink E board, refer to the installation manual of Superlink E board.

For electrical work, power source for all of units in the Superlink system must be turned OFF.

- ① Switch ON the DIP switch SW2-2 (Factory setting: ON) on the interface PCB.

Caution: Wireless remote control attached to the indoor unit can be used in parallel, after connecting the wired remote control. However, some of functions other than the basic functions such as RUN/STOP, temperature setting, etc. may not work properly and may have a mismatch between the display and the actual behavior.

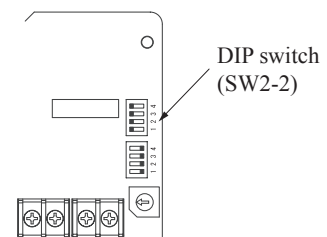

- ② Wiring connection between the interface and the Superlink E board.

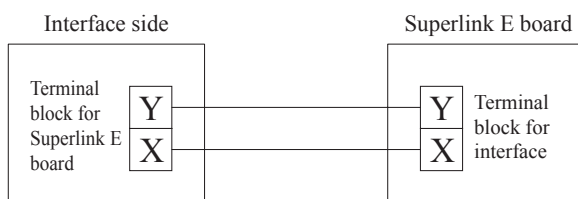

No.	Names of recommended signal wires
1	Shielded wire
2	Vinyl cabtyre round cord
3	Vinyl cabtyre round cable
4	Vinyl insulated wire vinyl sheathed cable for control

Within 200 m 0.5 mm² × 2 cores
 Within 300 m 0.75 mm² × 2 cores
 Within 400 m 1.25 mm² × 2 cores
 Within 600 m 2.0 mm² × 2 cores

- ③ Clamp the connection cables with cable clamps.

Connection of wired remote control

Regarding the connection of wired remote control, refer to the installation manual of wired remote control.

① Switch ON the DIP switch SW2-2 (Factory setting : ON) on the interface PCB.

Caution: Wireless remote control attached to the indoor unit can be used in parallel, after connecting the wired remote control. However, some of functions other than the basic functions such as RUN/STOP, temperature setting, etc. may not work properly and may have a mismatch between the display and the actual behavior.

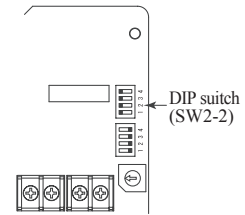

② Wiring connection between the interface and the wired remote control.

Installation and wiring of wired remote control

- Ⓐ Install the wired remote control with reference to the attached installation manual of wired remote control.
 - Ⓑ 0.3mm² × 2 cores cable should be used for the wiring of wired remote control.
 - Ⓒ Maximum length of wiring is 600m.
If the length of wiring exceeds 100m, change the size of cable as mentioned below.
100m-200m: 0.5mm² × 2 cores, 300m or less: 0.75mm² × 2 cores, 400m or less: 1.25mm² × 2 cores, 600m or less: 2.0mm² × 2 cores
However, cable size connecting to the terminal of wired remote control should not exceed 0.5mm². Accordingly if the size of connection cable exceeds 0.5mm², be sure to downsize it to 0.5mm² at the nearest section of the wired remote control and waterproof treatment should be done at the connecting section in order to avoid contact failure.
 - Ⓓ Don't use the multi-core cable to avoid malfunction.
 - Ⓔ Keep the wiring of wired remote control away from grounding (Don't touch it to any metal frame of building, etc.).
 - Ⓕ Connect the connection cables to the terminal blocks of the wired remote control and the interface securely (no polarity).
- ③ Clamp the connection cables with cable clamps.

Control of multiple units by a single wired remote control

Multiple units (up to 16) can be controlled by a single wired remote control. In this case, all units connected with a single wired remote control will operate under the same mode and same setting temperature.

- ① Connect all the interface with 2 cores cables of wired remote control line.
- ② Set the address of indoor unit for remote control communication from "0" to "F" with the rotary switch SW1 on the interface PCB.
- ③ After turning the power ON, the address of indoor unit can be displayed by pressing [AIR CON No.] button on the wired remote control.
Make sure all indoor units connected are displayed in order by pressing [▲] or [▼] button.

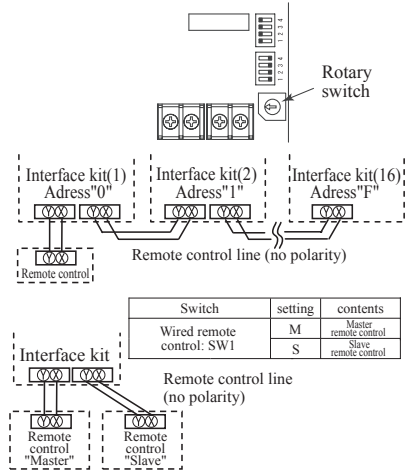

Master/Slave setting wired when 2 of wired remote control are used

- Maximum two wired remote control can be connected to one indoor unit (or one group of indoor units)
- ① Set the DIP switch SW1 on the wired remote control to "Slave" for the slave remote control. (Factory setting : Master)
 - Caution : Remote control sensor of the slave remote control is invalid.

- When using the wireless remote control in parallel with the wired remote control;
Since temperature setting range of wired remote control is different from that of wireless remote control, please adjust the setting range of wired remote control to be the same setting range of wireless remote control by following procedure. (The set temperature may not be displayed correctly on the wireless remote control, unless change of temperature setting range is done.)
Changing procedure of temperature setting range is as follows.

How to set upper and lower limit of temperature setting range

1. Stop the air-conditioner, and press [○] (SET) and [▽] (MODE) button at the same time for 3 seconds or more.
The indication changes to "FUNCTION SET ▼"
2. Press [▼] button once, and change to the "TEMP RANGE ▲" indication.
3. Press [○] (SET) button, and enter the temperature range setting mode.
4. Confirm that the "Upper limit ▼" is shown on the display.
5. Press [○] (SET) button to fix.
6. ① Indication: "∅ ∇ ∆ SET UP" → "UPPER 28°C ∇ ∆"
② Select the upper limit value 30°C with temperature setting button [∇]. "UPPER 30°C ∇" (blinking)
③ Press [○] (SET) button to fix. "UPPER 30°C" (Displayed for two seconds)
After the fixed upper limit value displayed for two seconds, the indication will return to "UPPER LIMIT ▼".
7. Press [▼] button once, "LOWER LIMIT ▲" is selected, press [○] (SET) button to fix.
① Indication: "∅ ∇ ∆ SET UP" → "LOWER 20°C ∇ ∆"
② Select the lower limit value 18°C with temperature setting button [∇]. "LOWER 18°C ∆" (blinking)
③ Press [○] (SET) button to fix. "LOWER 18°C" (Displayed for two seconds)
After the fixed lower limit value displayed for two seconds, the indication will return to "LOWER LIMIT ▼"
8. Press [ON/OFF] button to finish.

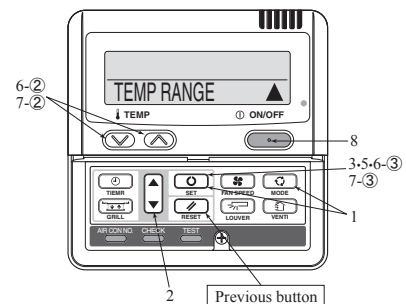

- It is possible to quit in the middle by pressing [ON/OFF] button, but the change of setting is incomplete.
- During setting, if pressing [∇] (RESET) button, it returns to the previous screen.

Mode	Temperature setting range
Cooling, Heating, Dry, Auto	18-30°C

(3) Superlink E board (SC-ADNA-E)

PJZ012D029K 

- Read and understand the instructions completely before starting installation.
- Refer to the instructions for both indoor and outdoor units.

Safety precautions

- Carefully read "Safety precautions" first. Follow the instructions for installation.
- Precautions are grouped into "Warning⚠" and "Caution⚠". The "Warning⚠" group includes items that may lead to serious injury or death if not observed. The items included in the "Caution⚠" group also may lead to serious results under certain conditions. Both groups are crucial for safety installation. Read and understand them carefully.
- After installation, conduct the test operation of the device to check for any abnormalities. Describe how to operate the device to the customer following the installation instruction manual. Instruct the customer to keep this installation instruction for future reference.

⚠WARNING

- This device should be installed by the dealer where you purchase the device or a licensed professional shop. If the device is incorrectly installed by the customer, it may result in electric shock or fire.
- Install the device carefully following the installation instruction. If the device is incorrectly installed, it may result in electric shock or fire.
- Use the accessory parts and specified parts for installation. If any parts that do not match the specifications are used, it may result in electric shock or fire.
- A person with the electrical service certification should conduct the service based on the "Technical standards for electrical facilities", "Electrical Wiring Code", and the installation instruction. If the work is done incorrectly, it may result in electric shock or fire.
- Wiring should be securely connected using the specified types of wire. No external force on the wire should be applied to any terminals. If a secure connection is not achieved, it may result in electric shock or fire.



⚠CAUTION

- Provide ground connection.
The ground line should never be connected to the gas supply piping, the water supply piping, the lightning conductor rod, nor the telephone ground. If the grounding is improper, it may result in electric shock.
- Do not install the device in the following locations.
 1. Where there is mist/spray of oil or steam such as kitchens.
 2. Where there is corrosive gases such as sulfurous acid gas.
 3. Where there is a device generating electromagnetic waves.
These may interfere with the control system resulting in the device becoming uncontrollable.
 4. Where flammable volatile materials such as paint thinner and gasoline may exist or where they are handled. This may cause a fire.

1 Application

Indoor-to-outdoor three core communication specification type 3 (since October 2007)

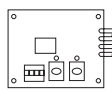
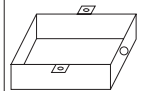
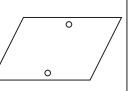
2 Accessories

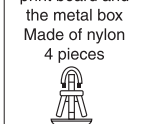
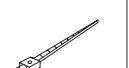
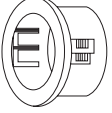
<p>SL E board</p> 	<p>Metal box</p> 	<p>Metal cover</p> 	<p>Screw for ground</p>  <p>M4x8 2 pieces</p>
<p>Pan head screws</p>  <p>φ4x8 2 pieces</p>	<p>Locking supports</p> <p>To secure the print board and the metal box Made of nylon 4 pieces</p> 	<p>Binding band</p> 	<p>Grommet</p> 

5 Connection outline

Note for setting the address

- Set the address between 00 and 47 for the previous Superlink connection and between 000 and 127 for the new Superlink connection. (*1)
- Do not set the address overlapping with those of the other devices in the network. (The default is 000)

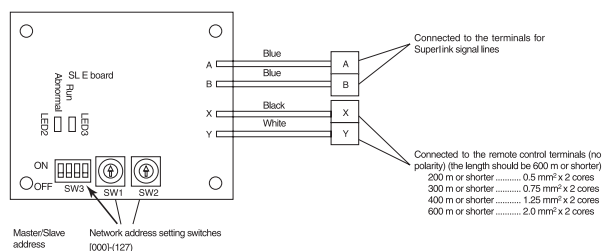

(*1) Whether the actual link is either the new Superlink or the previous Superlink depends on the models of the connected outdoor and indoor units. Consult the agent or the dealer.

3 Function

Allowing the center control SL1N-E, SL2N-E, and SL4-AE/BE to control and monitor the commercial air-conditioning unit.

4 Control switching

Settings can be changed by the switch SW3 on the SL E board as in the following.

Switch	Symbol	Switch	Remarks
SW3	1	ON	Master
		OFF (default)	Slave
	2	ON	Fixed previous protocol
		OFF (default)	Automatic adjustment of Superlink protocol
	3	ON	Indicates the forced operation stop when abnormality has occurred.
		OFF (default)	Indicates the status of running/stop as it is, when abnormality has occurred.
	4	ON	The hundredth address activated "1"
		OFF (default)	The hundredth address activated "0"

Signal line specification

Communication method	Previous Superlink	New Superlink
Line type	MVVS	MVVS
Line diameter	0.75 - 1.25mm ²	0.75/1.25mm ²
Signal line (total length)	up to 1000m	up to 1500/1000m (*2)
Signal line (maximum length)	up to 1000m	up to 1000m

(*2) Up to 1500 m for 0.75 mm², and up to 1000 m for 1.25 mm². Do not use 2.0 mm². It may cause an error.

(*3) Connect grounding on both ends of the shielding wire. For the grounding method, refer to the section "6 Installation".

- (1) Set the Superlink network address with SW1 (tens place), SW2 (ones place), and SW3 (hundreds place).
- (2) Set the SL E board SW3-1 to be ON (Master) when using this without any remote control (no wired remote control nor wireless remote control).
- (3) Set up the plural master/slave device using the dip switches on the indoor unit board.
- (4) Set up the remote control master/slave device using the slide switch on the remote control board.
- (5) Set up "0" to "F" using the address rotary switch on the indoor unit board when controlling the indoor unit with the multiple remote control.

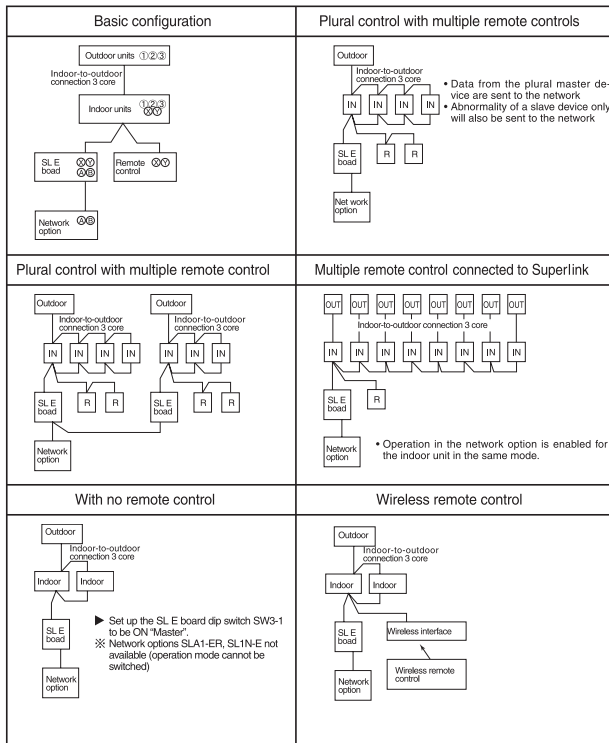

Connect grounding. Connect grounding for the power line to Ground ①, and grounding for the signal line to Ground ② or to the Ground on the indoor unit control box.

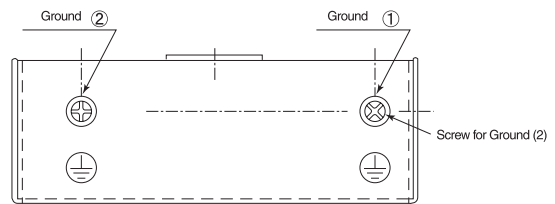

2. When connecting to the indoor unit control box (ceiling-concealed type and FDT type only):

- (1) Mount the SL E board in the control box using the locking supports.
- (2) Remove 6 bands from the box and put the wiring through the bands to be secured.

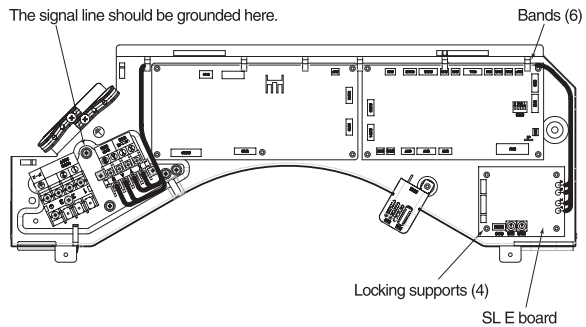

Electrical shock hazard! Make sure to turn the power off for servicing. Be cautious so that no abnormal force should be applied to the wiring. Do not let the SL E board hung by the wiring. Do not damage the board with a screw driver.

The board is sensitive to static electricity. Release the static electricity of your body before servicing.
(you can do this by touching the control board which is grounded).

Location of installation

Install the device at the location where there are no electromagnetic waves nor where there is water and dust. The specified temperature range of the device is 0 to 40°C. Install the device at the location where the ambient temperature stays within the range. If it exceeds the specification, make sure to provide solution such as installing a cooling fan. When used outside of the range, it may cause abnormal operation.

6 Installation

1. When using the metal box (mounted on the indoor unit / mounted on the back of the remote control):
 - (1) Mount the SL E board in the metal box using the locking supports.
 - (2) Wiring should go through the provided grommet since then through the wiring to the hole on the Metal box.
Secure the grommet after inserting the grommet into the Metal box as shown in below figure, then tie the wiring at the outlet of the unit using a binding band.

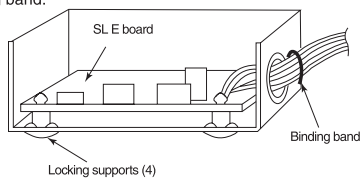

- ▲ When installed outside the indoor unit, put the metal cover on.

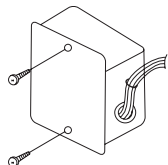

- ▲ When installed on the back of the remote control, mount it directly on the remote control bottom case.

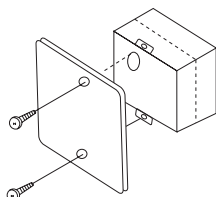

7 Indicator display

Check the LED 3 (green) and LED 2 (red) on the SL E board for flashing.

SL E board LEDs		Inspection mode	Display on the integrated network control device
Red	Green		
Off	Flashing	Normal communication	
Off	Off	<ul style="list-style-type: none"> • Disconnection in the remote control communication line (X or Y) • Short-circuit in the remote control communication line (between X and Y) • Faulty indoor unit remote control power • Faulty remote control communication circuit • Faulty CPU on SL E board 	No corresponding unit number
One flash	Flashing	<ul style="list-style-type: none"> • Disconnection in the Superlink signal line (A or B) • Short-circuit in the Superlink signal line (between A and B) • Faulty Superlink signal circuit 	
Two flashes	Flashing	<ul style="list-style-type: none"> • Faulty address setting for the SL E board (Set up the address for previous SL E board : more than 48 new SL E board : more than 128) 	
Three flashes	Flashing	<ul style="list-style-type: none"> • SL E board parent not set up when used without a remote control • Faulty remote control communication circuit 	E1
Four flashes	Flashing	<ul style="list-style-type: none"> • Address overlapping for the SL E board and the Superlink network connected indoor unit 	E2
Off	Flashing	<ul style="list-style-type: none"> • Number of connected devices exceeds the specification for the multiple indoor unit control 	E10

10. TECHNICAL INFORMATION

Model SRF25ZS-W

Information to identify the model(s) to which the information relates to:				If function includes heating: Indicate the heating season the information relates to. Indicated values should relate to one heating season at a time. Include at least the heating season 'Average'.					
Indoor unit model name		SRF25ZS-W		Average (mandatory)		Yes			
Outdoor unit model name		SRC25ZS-W2		Warmer (if designated)		Yes			
Function (indicate if present)				Colder (if designated)				No	
cooling		Yes							
heating		Yes							
Item	symbol	value	unit	Item	symbol	value	class		
Design load				Seasonal efficiency and energy efficiency class					
cooling	Pdesignc	2.50	kW	cooling	SEER	7.40	A++		
heating / Average	Pdesignh	2.40	kW	heating / Average	SCOP/A	4.00	A+		
heating / Warmer	Pdesignh	3.00	kW	heating / Warmer	SCOP/W	5.70	A+++		
heating / Colder	Pdesignh	-	kW	heating / Colder	SCOP/C	-	-		
				unit					
Declared capacity at outdoor temperature Tdesignh				Back up heating capacity at outdoor temperature Tdesignh					
heating / Average (-10°C)	Pdh	2.40	kW	heating / Average (-10°C)	elbu	-	kW		
heating / Warmer (2°C)	Pdh	3.00	kW	heating / Warmer (2°C)	elbu	-	kW		
heating / Colder (-22°C)	Pdh	-	kW	heating / Colder (-22°C)	elbu	-	kW		
Declared capacity for cooling, at indoor temperature 27(19)°C and outdoor temperature Tj				Declared energy efficiency ratio, at indoor temperature 27(19)°C and outdoor temperature Tj					
Tj=35°C	Pdc	2.50	kW	Tj=35°C	EERd	4.24	-		
Tj=30°C	Pdc	1.80	kW	Tj=30°C	EERd	6.32	-		
Tj=25°C	Pdc	1.20	kW	Tj=25°C	EERd	10.20	-		
Tj=20°C	Pdc	1.10	kW	Tj=20°C	EERd	15.20	-		
Declared capacity for heating / Average season, at indoor temperature 20°C and outdoor temperature Tj				Declared coefficient of performance / Average season, at indoor temperature 20°C and outdoor temperature Tj					
Tj=-7°C	Pdh	2.10	kW	Tj=-7°C	COPd	2.60	-		
Tj=2°C	Pdh	1.30	kW	Tj=2°C	COPd	3.70	-		
Tj=7°C	Pdh	0.90	kW	Tj=7°C	COPd	5.65	-		
Tj=12°C	Pdh	1.10	kW	Tj=12°C	COPd	7.48	-		
Tj=bivalent temperature	Pdh	2.40	kW	Tj=bivalent temperature	COPd	2.60	-		
Tj=operating limit	Pdh	2.40	kW	Tj=operating limit	COPd	2.60	-		
Declared capacity for heating / Warmer season, at indoor temperature 20°C and outdoor temperature Tj				Declared coefficient of performance / Warmer season, at indoor temperature 20°C and outdoor temperature Tj					
Tj=2°C	Pdh	3.00	kW	Tj=2°C	COPd	2.99	-		
Tj=7°C	Pdh	1.90	kW	Tj=7°C	COPd	5.18	-		
Tj=12°C	Pdh	1.10	kW	Tj=12°C	COPd	7.48	-		
Tj=bivalent temperature	Pdh	3.00	kW	Tj=bivalent temperature	COPd	2.99	-		
Tj=operating limit	Pdh	3.00	kW	Tj=operating limit	COPd	2.99	-		
Declared capacity for heating / Colder season, at indoor temperature 20°C and outdoor temperature Tj				Declared coefficient of performance / Colder season, at indoor temperature 20°C and outdoor temperature Tj					
Tj=-7°C	Pdh	-	kW	Tj=-7°C	COPd	-	-		
Tj=2°C	Pdh	-	kW	Tj=2°C	COPd	-	-		
Tj=7°C	Pdh	-	kW	Tj=7°C	COPd	-	-		
Tj=12°C	Pdh	-	kW	Tj=12°C	COPd	-	-		
Tj=bivalent temperature	Pdh	-	kW	Tj=bivalent temperature	COPd	-	-		
Tj=operating limit	Pdh	-	kW	Tj=operating limit	COPd	-	-		
Tj=-15°C	Pdh	-	kW	Tj=-15°C	COPd	-	-		
Bivalent temperature				Operating limit temperature					
heating / Average	Tbiv	-10	°C	heating / Average	Tol	-10	°C		
heating / Warmer	Tbiv	2	°C	heating / Warmer	Tol	2	°C		
heating / Colder	Tbiv	-	°C	heating / Colder	Tol	-	°C		
Cycling interval capacity				Cycling interval efficiency					
for cooling	Pcycc	-	kW	for cooling	EERcyc	-	-		
for heating	Pcyh	-	kW	for heating	COPcyc	-	-		
Degradation coefficient				Degradation coefficient					
cooling	Cdc	0.25	-	heating	Cdh	0.25	-		
Electric power input in power modes other than 'active mode'				Annual electricity consumption					
off mode	Poff	7	W	cooling	Qce	119	kWh/a		
standby mode	Psb	7	W	heating / Average	Qhe	840	kWh/a		
thermostat-off mode	Pto(cooling)	12	W	heating / Warmer	Qhe	737	kWh/a		
	Pto(heating)	15	W	heating / colder	Qhe	-	kWh/a		
crankcase heater mode	Pck	0	W						
Capacity control (indicate one of three options)				Other items					
fixed		No		Sound power level (indoor)	Lwa	50	dB(A)		
staged		No		Sound power level (outdoor)	Lwa	59	dB(A)		
variable		Yes		Global warming potential	GWP	675	kgCO ₂ eq.		
				Rated air flow (indoor)		540	m ³ /h		
				Rated air flow (outdoor)		1644	m ³ /h		
Contact details for obtaining more information	Name and address of the manufacturer or of its authorised representative. Mitsubishi Heavy Industries Air-Conditioning Europe, Ltd. 5 The Square, Stockley Park, Uxbridge, Middlesex, UB11 1ET, United Kingdom								

Model SRF35ZS-W

Information to identify the model(s) to which the information relates to:				If function includes heating: Indicate the heating season the information relates to. Indicated values should relate to one heating season at a time. Include at least the heating season 'Average'.					
Indoor unit model name		SRF35ZS-W		Average (mandatory)		Yes			
Outdoor unit model name		SRC35ZS-W2		Warmer (if designated)		Yes			
Function (indicate if present)				Colder (if designated)				No	
cooling		Yes							
heating		Yes							
Item	symbol	value	unit	Item	symbol	value	class		
Design load				Seasonal efficiency and energy efficiency class					
cooling	Pdesignc	3.50	kW	cooling	SEER	8.10	A++		
heating / Average	Pdesignh	2.90	kW	heating / Average	SCOP/A	4.70	A++		
heating / Warmer	Pdesignh	3.80	kW	heating / Warmer	SCOP/W	5.90	A+++		
heating / Colder	Pdesignh	-	kW	heating / Colder	SCOP/C	-	-		
Declared capacity at outdoor temperature Tdesignh				Back up heating capacity at outdoor temperature Tdesignh					
heating / Average (-10°C)	Pdh	2.90	kW	heating / Average (-10°C)	elbu	-	kW		
heating / Warmer (2°C)	Pdh	3.80	kW	heating / Warmer (2°C)	elbu	-	kW		
heating / Colder (-22°C)	Pdh	-	kW	heating / Colder (-22°C)	elbu	-	kW		
Declared capacity for cooling, at indoor temperature 27(19)°C and outdoor temperature Tj				Declared energy efficiency ratio, at indoor temperature 27(19)°C and outdoor temperature Tj					
Tj=35°C	Pdc	3.50	kW	Tj=35°C	EERd	4.27	-		
Tj=30°C	Pdc	2.60	kW	Tj=30°C	EERd	6.47	-		
Tj=25°C	Pdc	1.60	kW	Tj=25°C	EERd	10.10	-		
Tj=20°C	Pdc	1.20	kW	Tj=20°C	EERd	18.90	-		
Declared capacity for heating / Average season, at indoor temperature 20°C and outdoor temperature Tj				Declared coefficient of performance / Average season, at indoor temperature 20°C and outdoor temperature Tj					
Tj=-7°C	Pdh	2.50	kW	Tj=-7°C	COPd	2.86	-		
Tj=2°C	Pdh	1.60	kW	Tj=2°C	COPd	4.90	-		
Tj=7°C	Pdh	1.00	kW	Tj=7°C	COPd	5.70	-		
Tj=12°C	Pdh	1.00	kW	Tj=12°C	COPd	7.30	-		
Tj=bivalent temperature	Pdh	2.90	kW	Tj=bivalent temperature	COPd	2.60	-		
Tj=operating limit	Pdh	2.90	kW	Tj=operating limit	COPd	2.60	-		
Declared capacity for heating / Warmer season, at indoor temperature 20°C and outdoor temperature Tj				Declared coefficient of performance / Warmer season, at indoor temperature 20°C and outdoor temperature Tj					
Tj=2°C	Pdh	3.80	kW	Tj=2°C	COPd	2.99	-		
Tj=7°C	Pdh	2.40	kW	Tj=7°C	COPd	5.36	-		
Tj=12°C	Pdh	1.00	kW	Tj=12°C	COPd	7.30	-		
Tj=bivalent temperature	Pdh	3.80	kW	Tj=bivalent temperature	COPd	2.99	-		
Tj=operating limit	Pdh	3.80	kW	Tj=operating limit	COPd	2.99	-		
Declared capacity for heating / Colder season, at indoor temperature 20°C and outdoor temperature Tj				Declared coefficient of performance / Colder season, at indoor temperature 20°C and outdoor temperature Tj					
Tj=-7°C	Pdh	-	kW	Tj=-7°C	COPd	-	-		
Tj=2°C	Pdh	-	kW	Tj=2°C	COPd	-	-		
Tj=7°C	Pdh	-	kW	Tj=7°C	COPd	-	-		
Tj=12°C	Pdh	-	kW	Tj=12°C	COPd	-	-		
Tj=bivalent temperature	Pdh	-	kW	Tj=bivalent temperature	COPd	-	-		
Tj=operating limit	Pdh	-	kW	Tj=operating limit	COPd	-	-		
Tj=-15°C	Pdh	-	kW	Tj=-15°C	COPd	-	-		
Bivalent temperature				Operating limit temperature					
heating / Average	Tbiv	-10	°C	heating / Average	Tol	-10	°C		
heating / Warmer	Tbiv	2	°C	heating / Warmer	Tol	2	°C		
heating / Colder	Tbiv	-	°C	heating / Colder	Tol	-	°C		
Cycling interval capacity				Cycling interval efficiency					
for cooling	Pcycc	-	kW	for cooling	EERcyc	-	-		
for heating	Pcyh	-	kW	for heating	COPcyc	-	-		
Degradation coefficient				Degradation coefficient					
cooling	Cdc	0.25	-	heating	Cdh	0.25	-		
Electric power input in power modes other than 'active mode'				Annual electricity consumption					
off mode	Poff	7	W	cooling	Qce	152	kWh/a		
standby mode	Psb	7	W	heating / Average	Qhe	864	kWh/a		
thermostat-off mode	Pto(cooling)	12	W	heating / Warmer	Qhe	902	kWh/a		
	Pto(heating)	15	W	heating / colder	Qhe	-	kWh/a		
crankcase heater mode	Pck	0	W						
Capacity control (indicate one of three options)				Other items					
fixed		No		Sound power level (indoor)	Lwa	51	dB(A)		
staged		No		Sound power level (outdoor)	Lwa	63	dB(A)		
variable		Yes		Global warming potential	GWP	675	kgCO ₂ eq.		
Contact details for obtaining more information				Name and address of the manufacturer or of its authorised representative.					
				Mitsubishi Heavy Industries Air-Conditioning Europe, Ltd. 5 The Square, Stockley Park, Uxbridge, Middlesex, UB11 1ET, United Kingdom					

Model SRF50ZSX-W

Information to identify the model(s) to which the information relates to:				If function includes heating: Indicate the heating season the information relates to. Indicated values should relate to one heating season at a time. Include at least the heating season 'Average'.					
Indoor unit model name		SRF50ZSX-W		Average (mandatory)		Yes			
Outdoor unit model name		SRC50ZSX-W2		Warmer (if designated)		Yes			
Function (indicate if present)				Colder (if designated)				No	
cooling		Yes							
heating		Yes							
Item	symbol	value	unit	Item	symbol	value	class		
Design load				Seasonal efficiency and energy efficiency class					
cooling	Pdesignc	5.00	kW	cooling	SEER	7.50	A++		
heating / Average	Pdesignh	4.10	kW	heating / Average	SCOP/A	4.60	A++		
heating / Warmer	Pdesignh	5.60	kW	heating / Warmer	SCOP/W	5.60	A+++		
heating / Colder	Pdesignh	-	kW	heating / Colder	SCOP/C	-	-		
Declared capacity at outdoor temperature Tdesignh				Back up heating capacity at outdoor temperature Tdesignh					
heating / Average (-10°C)	Pdh	4.10	kW	heating / Average (-10°C)	elbu	-	kW		
heating / Warmer (2°C)	Pdh	5.60	kW	heating / Warmer (2°C)	elbu	-	kW		
heating / Colder (-22°C)	Pdh	-	kW	heating / Colder (-22°C)	elbu	-	kW		
Declared capacity for cooling, at indoor temperature 27(19)°C and outdoor temperature Tj				Declared energy efficiency ratio, at indoor temperature 27(19)°C and outdoor temperature Tj					
Tj=35°C	Pdc	5.00	kW	Tj=35°C	EERd	3.79	-		
Tj=30°C	Pdc	3.70	kW	Tj=30°C	EERd	5.76	-		
Tj=25°C	Pdc	2.30	kW	Tj=25°C	EERd	9.10	-		
Tj=20°C	Pdc	1.50	kW	Tj=20°C	EERd	14.90	-		
Declared capacity for heating / Average season, at indoor temperature 20°C and outdoor temperature Tj				Declared coefficient of performance / Average season, at indoor temperature 20°C and outdoor temperature Tj					
Tj=-7°C	Pdh	3.70	kW	Tj=-7°C	COPd	3.14	-		
Tj=2°C	Pdh	2.20	kW	Tj=2°C	COPd	4.53	-		
Tj=7°C	Pdh	1.40	kW	Tj=7°C	COPd	5.70	-		
Tj=12°C	Pdh	1.10	kW	Tj=12°C	COPd	7.35	-		
Tj=bivalent temperature	Pdh	4.10	kW	Tj=bivalent temperature	COPd	2.34	-		
Tj=operating limit	Pdh	4.10	kW	Tj=operating limit	COPd	2.34	-		
Declared capacity for heating / Warmer season, at indoor temperature 20°C and outdoor temperature Tj				Declared coefficient of performance / Warmer season, at indoor temperature 20°C and outdoor temperature Tj					
Tj=2°C	Pdh	5.60	kW	Tj=2°C	COPd	2.58	-		
Tj=7°C	Pdh	3.60	kW	Tj=7°C	COPd	4.86	-		
Tj=12°C	Pdh	1.60	kW	Tj=12°C	COPd	7.31	-		
Tj=bivalent temperature	Pdh	5.60	kW	Tj=bivalent temperature	COPd	2.58	-		
Tj=operating limit	Pdh	5.60	kW	Tj=operating limit	COPd	2.58	-		
Declared capacity for heating / Colder season, at indoor temperature 20°C and outdoor temperature Tj				Declared coefficient of performance / Colder season, at indoor temperature 20°C and outdoor temperature Tj					
Tj=-7°C	Pdh	-	kW	Tj=-7°C	COPd	-	-		
Tj=2°C	Pdh	-	kW	Tj=2°C	COPd	-	-		
Tj=7°C	Pdh	-	kW	Tj=7°C	COPd	-	-		
Tj=12°C	Pdh	-	kW	Tj=12°C	COPd	-	-		
Tj=bivalent temperature	Pdh	-	kW	Tj=bivalent temperature	COPd	-	-		
Tj=operating limit	Pdh	-	kW	Tj=operating limit	COPd	-	-		
Tj=-15°C	Pdh	-	kW	Tj=-15°C	COPd	-	-		
Bivalent temperature				Operating limit temperature					
heating / Average	Tbiv	-10	°C	heating / Average	Tol	-10	°C		
heating / Warmer	Tbiv	2	°C	heating / Warmer	Tol	2	°C		
heating / Colder	Tbiv	-	°C	heating / Colder	Tol	-	°C		
Cycling interval capacity				Cycling interval efficiency					
for cooling	Pcycc	-	kW	for cooling	EERcyc	-	-		
for heating	Pcyh	-	kW	for heating	COPcyc	-	-		
Degradation coefficient				Degradation coefficient					
cooling	Cdc	0.25	-	heating	Cdh	0.25	-		
Electric power input in power modes other than 'active mode'				Annual electricity consumption					
off mode	Poff	6	W	cooling	Qce	234	kWh/a		
standby mode	Psb	6	W	heating / Average	Qhe	1247	kWh/a		
thermostat-off mode	Pto(cooling)	13	W	heating / Warmer	Qhe	1400	kWh/a		
	Pto(heating)	15	W	heating / colder	Qhe	-	kWh/a		
crankcase heater mode	Pck	0	W						
Capacity control (indicate one of three options)				Other items					
fixed		No		Sound power level (indoor)	Lwa	58	dB(A)		
staged		No		Sound power level (outdoor)	Lwa	63	dB(A)		
variable		Yes		Global warming potential	GWP	675	kgCO ₂ eq.		
Contact details for obtaining more information				Name and address of the manufacturer or of its authorised representative.					
				Mitsubishi Heavy Industries Air-Conditioning Europe, Ltd.					
				5 The Square, Stockley Park, Uxbridge, Middlesex, UB11 1ET,					
				United Kingdom					

INVERTER FLOOR STANDING TYPE RESIDENTIAL AIR-CONDITIONERS



MITSUBISHI HEAVY INDUSTRIES THERMAL SYSTEMS, LTD.
2-3, Marunouchi 3-chome, Chiyoda-ku, Tokyo, 100-8332, Japan
<http://www.mhi-mth.co.jp/en/>

Because of our policy of continuous improvement, we reserve the right to make changes in all specifications without notice.

© Copyright MITSUBISHI HEAVY INDUSTRIES THERMAL SYSTEMS, LTD.